

# **4000 Series**

## **Precision Multi Product Calibrator**

### **Operation Manual**

# **IMPORTANT NOTICE**

**THIS CALIBRATOR  
WILL  
REQUIRE AN  
UNLOCK CODE  
AFTER THE EVALUATION  
PERIOD HAS EXPIRED.**

**(60 Days after invoice date)**

**AFTER THE EVALUATION PERIOD HAS EXPIRED THE  
OPERATION OF THE CALIBRATOR IS LOCKED AND THE DISPLAY  
SHOWS A NUMBER WHICH MUST BE QUOTED TO TRANSMILLE  
TO RECEIVE THE UNLOCK CODE**

**THE UNLOCK CODE IS AVAILALBLE  
FROM TRANSMILLE  
ONLY AFTER PAYMENT  
HAS BEEN RECEIVED.**

**This code only needs to be entered once  
in the life of the instrument.**

**Please contact Transmille or use the form in the  
back of the manual to obtain the unlock code.**

**Transmille Ltd.  
Staplehurst, Kent.  
Tel: 44 (0)1580 890700 Fax: 44(0)1580 890711  
Email: [sales@transmille.com](mailto:sales@transmille.com)**

# DECLARATION OF CONFORMITY



**Manufacturer's Name:** Transmille Ltd.  
**Manufacturer's Address:** Unit 4, Select Business Centre  
Lodge Road  
Staplehurst  
TN12 0QW

**Declares, that the product**

**Product Name:** Advanced Multi-Product Calibrator  
**Model Number:** 4000 Series  
**Product Options:** This declaration covers all options of the above product(s)

**Conforms with the following European Directives:**

*The product herewith complies with the requirements of the Low Voltage Directive 73/73EEC and the EMC Directive 89/336/EEC (including 93/68/EEC) and carries the CE Marking accordingly*

**Conforms with the following product standards:**

## EMC

**EN 61326-1:1997+A1:1998 • EN55011:1991 (Group 1: Class A)**

Standard	Limit
IEC 61000-4-2:1995+A1:1998 / EN 61000-4-2:1995	4kV CD, 8kV AD
IEC 61000-4-3:1995 / EN 61000-4-3:1995	3 V/m, 80-1000 MHz
IEC 61000-4-4:1995 / EN 61000-4-4:1995	0.5kV signal lines, 1kV power lines
IEC 61000-4-5:1995 / EN 61000-4-5:1995	0.5kV line-line, 1kV line-ground
IEC 61000-4-6:1996 / EN 61000-4-6:1996	3V, 0.15-80 MHz / cycle, 100%
IEC 61000-4-11:1994 / EN 61000-4-11:1994	Dips: 30% 10ms; 60% 100ms Interrupt > 95% @5000ms

## SAFETY

**IEC 61010-1:1990+A1:1992+A2:1995 / EN 61010-1:1993+A2:1995**

16/01/2015

**Revision No: 1.0**  
**Date: 16/01/2015**

**Managing Director**

# TABLE OF CONTENTS

<b>1</b>	<b>INTRODUCTION .....</b>	<b>12</b>
1.1	MAIN FEATURES .....	12
1.2	ACCURACY AND FUNCTIONALITY .....	13
1.3	TRUE MULTIPRODUCT CALIBRATION .....	13
1.4	RETRO FIT OPTIONS .....	14
1.5	USB INTERFACE .....	14
1.6	OUTPUT CONNECTIONS.....	14
<b>2</b>	<b>PREPARING THE CALIBRATOR FOR USE. ....</b>	<b>15</b>
2.1	INITIAL INSPECTION .....	15
2.2	LIFTING AND CARRYING THE CALIBRATOR .....	15
2.3	POSITIONING THE CALIBRATOR.....	16
2.4	REAR PANEL CONNECTIONS AND CONTROLS .....	17
2.5	SETTING AND CHECKING THE LINE VOLTAGE.....	18
2.6	POWER LINE INLET FUSE AND RATING .....	18
2.7	INTERFACE TYPES .....	19
2.8	USB INTERFACE .....	19
2.9	CONNECTING TO A COMPUTER.....	19
2.10	POWERING UP THE CALIBRATOR .....	21
2.11	OUTPUT CONNECTIONS.....	22
2.12	WARNING AND OUTPUT OVERLOAD INDICATIONS. ....	24
2.13	HIGH VOLTAGE TIMEOUT.....	25
2.14	30 AMP TEMPERATURE CUT-OUT .....	25
<b>3</b>	<b>OPERATION.....</b>	<b>26</b>
3.1	SAFETY WARNINGS.....	26
3.2	INTRODUCTION TO OPERATION .....	26
3.3	FRONT PANEL CONTROLS .....	27
	<i>Numerical Keypad.....</i>	<i>29</i>
	<i>Multiplier Keys.....</i>	<i>29</i>
	<i>Function Keys .....</i>	<i>29</i>
	<i>Range Up / Range Down Keys .....</i>	<i>29</i>
	<i>Left / Right / Up / Down Arrow Keys .....</i>	<i>29</i>
	<i>Output On / Standby keys.....</i>	<i>30</i>
3.4	DIGITAL CONTROL.....	30
3.5	FRONT PANEL USB CONNECTOR .....	31
3.6	TOUCHSCREEN INTERFACE FUNCTIONALITY .....	31

3.7 CONNECTION HELP PROMPTS .....	33
3.8 MAIN MENU .....	34
3.9 CONFIGURATION MENU .....	36
3.10 VIEW HARDWARE CONFIGURATION .....	38
3.11 SET PASSCODE .....	39
3.12 CONFIGURING TEST REPORT NUMBER .....	40
3.13 CONFIGURING REFERENCE MULTIMETER .....	43
3.14 UPDATING FIRMWARE VIA USB .....	45
3.15 SPECIAL FUNCTIONS AVAILABLE USING THE 'SOFT' KEYS .....	48
3.16 CONNECTING OUTPUT NEGATIVE TO LINE EARTH (GROUND) .....	48
3.17 SELECTING FRONT PANEL CONTROL .....	48
3.18 TERMINAL STATUS LED'S .....	50
<i>Voltage Output Terminal Pair (Black &amp; Red)</i> .....	52
<i>Current Output Terminals (Black &amp; Red)</i> .....	52
<i>30 Amps Output Terminals (Blue and Yellow)</i> .....	52
<i>Earth Terminal (Green)</i> .....	52
<i>Scope &amp; Frequency BNC Connector Outputs</i> .....	52
<i>High Bandwidth Connector Output</i> .....	52
3.19 9 PIN ADAPTER INTERFACE CONNECTOR .....	53
<b>4 CONNECTION DIAGRAMS .....</b>	<b>54</b>
4.1 AC/DC VOLTAGE .....	54
4.2 AC/DC CURRENT UP TO 2A .....	54
4.3 AC/DC CURRENT ABOVE 2A .....	55
4.4 2 WIRE RESISTANCE / VARIABLE RESISTANCE / VARIABLE PRT .....	56
4.5 4 WIRE RESISTANCE / PASSIVE PRT .....	56
4.6 PASSIVE CAPACITANCE / VARIABLE CAPACITANCE .....	57
4.7 INDUCTANCE (OPTIONAL) .....	57
4.8 FREQUENCY .....	58
4.9 PULSE WIDTH MODULATION (PWM) / DUTY CYCLE .....	58
4.10 THERMOCOUPLE SOURCE USING EA001A .....	59
4.11 CURRENT SIMULATION UP TO 1500A USING EA002 COIL ADAPTER .....	59
4.12 RPM SIMULATION USING EA003 .....	60
4.13 OSCILLOSCOPE AMPLITUDE / TIMEBASE / RISE TIME .....	60
4.14 OSCILLOSCOPE HIGH BANDWIDTH .....	61
4.15 POWER CALIBRATION .....	61
<b>5 SETTING OUTPUTS .....</b>	<b>62</b>
5.1 ADJUSTING THE SET OUTPUT USING THE DIGITAL CONTROL .....	63
5.2 AUTOMATIC DISPLAY OF % OR PPM ERROR AND REFERENCE KEY .....	63
5.3 RANGE HOLD .....	63

5.4	LOW IMPEDANCE LOADS.....	64
5.5	SETTING A DC VOLTAGE OUTPUT.....	65
5.6	SETTING A DC CURRENT OUTPUT .....	66
5.7	SETTING A AC VOLTAGE OUTPUT .....	67
5.8	SETTING A AC CURRENT OUTPUT .....	68
5.9	SETTING 2 WIRE PASSIVE RESISTANCE OUTPUT.....	69
5.10	SETTING 2-WIRE SIMULATED RESISTANCE (OPTION).....	71
5.11	SETTING 4-WIRE RESISTANCE OUTPUT .....	74
5.12	USING CURRENT COILS (OPTION).....	76
5.13	SETTING CAPACITANCE (PASSIVE) OUTPUT .....	77
5.14	SETTING CAPACITANCE (SIMULATED) OUTPUT .....	79
5.15	SETTING INDUCTANCE OUTPUT (OPTION).....	81
5.16	THERMOCOUPLE SIMULATION (OPTION) .....	83
5.17	SETTING FREQUENCY OUTPUT .....	86
5.18	SETTING RPM OUTPUT WITH EA003 ADAPTOR (OPTION) .....	88
5.19	SETTING PULSE WIDTH MODULATION (PWM, MARK SPACE RATIO) .....	90
5.20	SELECTING PRT (PT100) RESISTANCE OUTPUT (OPTION).....	91
5.21	SELECTING SIMULATED PRT OUTPUT (OPTION).....	92
5.22	SELECTING AC POWER CALIBRATION OUTPUT (OPTION) .....	94
5.23	SELECTING DC POWER CALIBRATION OUTPUT (OPTION).....	97
5.24	DDS POWER (OPTION) .....	99
5.25	OSCILLOSCOPE CALIBRATION OUTPUT (OPTION).....	101
<b>6</b>	<b>PROCEDURE MODE .....</b>	<b>105</b>
6.1	CREATING PROCEDURES.....	105
6.2	IMPORTING PROCEDURES .....	105
<b>7</b>	<b>VERIFICATION MODE.....</b>	<b>106</b>
7.1	EQUIPMENT REQUIRED .....	107
7.2	CONFIGURING FOR MEASUREMENTS.....	108
7.3	PERFORMING VERIFICATION .....	108
<b>8</b>	<b>REMOTE PROGRAMMING .....</b>	<b>115</b>
8.1	RESPONSE / ERROR CODES .....	116
8.2	LEGACY COMMANDS .....	117
8.3	PROGRAMMING COMMANDS OVERVIEW .....	117
8.4	COMPOUND COMMANDS .....	117
8.5	OUTPUT STATE.....	119
8.6	DC VOLTAGE COMMANDS .....	119
8.7	AC VOLTAGE COMMANDS .....	121
8.7.1	<i>Additional examples:</i> .....	122

8.8 DC CURRENT COMMANDS.....	123
8.9 AC CURRENT COMMANDS.....	125
8.10 PASSIVE RESISTANCE COMMANDS.....	127
8.11 PASSIVE CAPACITANCE COMMANDS .....	129
8.12 SIMULATED RESISTANCE COMMANDS (OPTION) .....	130
8.13 VARIABLE CAPACITANCE COMMANDS (OPTION).....	132
8.14 FREQUENCY COMMANDS (OPTION).....	134
8.15 PULSE WIDTH MODULATION COMMANDS (OPTION).....	136
8.16 INDUCTANCE COMMANDS (OPTION) .....	139
8.17 PASSIVE PRT COMMANDS (OPTION) .....	141
8.18 VARIABLE PRT COMMANDS (OPTION).....	143
8.19 THERMOCOUPLE SIMULATION COMMANDS (OPTION) .....	145
8.20 OSCILLOSCOPE CALIBRATION COMMANDS (OPTION) .....	148
8.20.1 Amplitude.....	148
8.20.2 Timebase.....	151
8.20.3 Bandwidth (Levelled) Sweep – SCP350/SCP600.....	154
8.20.4 Bandwidth (Levelled) Sweep – SCP6400 .....	156
8.20.5 Bandwidth 50kHz Reference.....	158
8.21 AC POWER CALIBRATION COMMANDS (OPTION) .....	159
8.22 MISCELLANEOUS COMMANDS .....	162
8.22.1 Earth Relay (Floating or Grounded negative terminals).....	162
8.22.2 Reset Calibrator.....	162
8.22.3 System ID .....	162
8.22.4 Calibration Mode Enable / Disable .....	163
8.22.5 Transmit Displayed Reading .....	163
<b>9 TECHNICAL DESCRIPTION.....</b>	<b>164</b>
9.1 GENERAL .....	164
9.2 CONSTRUCTION.....	164
9.3 INTERNAL FUSES .....	165
9.4 OPENING THE CASE.....	166
9.5 ACCESS TO INTERNAL FUSES – TOP BOARD.....	168
9.6 ACCESS TO INTERNAL FUSES – FRONT PANEL PCB .....	169
9.7 POWER SUPPLY AND OUTPUT SWITCHING BOARD .....	170
9.8 PROCESSOR BOARD .....	170
9.9 MAIN ANALOGUE AMPLIFIER AND FEEDBACK BOARD .....	170
9.10 HIGH VOLTAGE AMPLIFIER AND OUTPUT .....	171
9.11 CURRENT TRANS CONDUCTANCE AMPLIFIER .....	171
9.12 OUTPUT CURRENTS SENSING & SHUNTS .....	172
<b>10 CALIBRATION TUTORIAL.....</b>	<b>173</b>

10.1 GETTING THE BEST OUT OF THE CALIBRATOR.....	173
10.2 MAKING GOOD MEASUREMENTS.....	173
10.3 THERMALLY GENERATED EMF VOLTAGE ERRORS.....	173
10.4 LEAD/CONNECTION RESISTANCE.....	174
10.5 POWER LINE AND LOW FREQUENCY PICK UP AND NOISE.....	175
<b>11 CALIBRATION AND MAINTENANCE.....</b>	<b>176</b>
11.1 GENERAL.....	176
11.2 ELECTRICAL SAFETY TESTS.....	176
11.3 CLEANING OF THE FAN DUCT.....	177
11.4 CLEANING THE EXTERNAL CASE.....	177
11.5 CALIBRATION.....	178
<b>12 GUARANTEE AND SERVICE.....</b>	<b>179</b>
<b>APPENDIX A.....</b>	<b>181</b>
INSTALLING THE USB INTERFACE DRIVER (WINDOWS XP).....	181
INSTALLING THE USB INTERFACE DRIVER (WINDOWS VISTA / 7).....	183
CHECKING THE COM PORT SETTING FOR THE USB INTERFACE.....	185



# LIST OF FIGURES

Figure 1 - The 4010 Advanced Multiproduct Calibrator.....	12
Figure 2 - Minimum Clearance Required .....	16
Figure 3 - Rear Panel Connections and Controls.....	17
Figure 4 - Power Line Fuse.....	18
Figure 5 - USB Cable Connection from PC to Instrument.....	19
Figure 6 - Supplied USB driver .....	20
Figure 7 - 4000 Series Front Panel .....	27
Figure 8 - Front Panel Digital Control.....	30
Figure 9 – USB Device Port.....	31
Figure 10 – 7 Inch High Resolution LCD Touchscreen .....	32
Figure 11 – Connection Help Screen .....	33
Figure 12 - Main Menu Screen.....	34
Figure 13 - Configuration Screen .....	36
Figure 14 – Configuration Menu.....	38
Figure 15 – Unit Configuration prompt.....	38
Figure 16 – Set Passcode Selected .....	39
Figure 17 – Enter New Passcode Prompt.....	39
Figure 18 – Confirmation of change to Passcode .....	40
Figure 19 – Set Test Report Number selected.....	41
Figure 20 – Enter New Test Report Number Prompt .....	41
Figure 21 – Confirmation of change to Test Report number .....	42
Figure 22 – Reference Meter Selection .....	43
Figure 23 – Reference Meter Configuration Menu .....	44
Figure 24 – Reference Meter GPIB Address Entry .....	44
Figure 25 – Update Firmware via USB Selected.....	45
Figure 26 - Firmware Update Progress Indication.....	46
Figure 27 – Firmware Update Successful .....	46
Figure 28 – Firmware Update Error Message 1 .....	47
Figure 29 – Firmware Update Error Message 2 .....	47
Figure 30 - Negative to Line Earth Indication.....	48
Figure 31 – Local Key .....	49
Figure 32 – Active Terminal LED's.....	50
Figure 33 - Adapter Interface 9 Way 'D' Type Connector (Female) .....	53
Figure 34 – AC / DC Voltage Connection .....	54
Figure 35 – AC / DC Current up to 2A .....	55
Figure 36 – AC / DC Current above 2A.....	55
Figure 37 – 2 Wire Resistance / Variable Resistance / Variable PRT .....	56
Figure 38 – 4 Wire Resistance / Passive PRT .....	56
Figure 39 – Passive Capacitance / Variable Capacitance .....	57
Figure 40 - Inductance .....	57
Figure 41 - Frequency.....	58
Figure 42 – Pulse Width Modulation (PWM) / Duty Cycle.....	58
Figure 43 - Thermocouple Source Using EA001A .....	59
Figure 44 – Current simulation up to 1500A using Ea002 Coil Adapter .....	59
Figure 45 - RPM Simulation Using EA003 .....	60
Figure 46 – Oscilloscope Amplitude / Timebase / Rise Time .....	60
Figure 47 – Oscilloscope High Bandwidth .....	61

Figure 48 – Power Calibration.....	61
Figure 49 – Position of % or PPM error from Reference Value.....	63
Figure 50 – Range Hold Key.....	64
Figure 51 – Direct resistance selection keys.....	70
Figure 52 - Resistance (Passive) Selection Using the Function Menu.....	70
Figure 53 - Soft Key and Direct Touch Selection of 2-Wire Mode.....	71
Figure 54 – Soft Key and Direct Touch Selection of Simulated Resistance.....	72
Figure 55 - Resistance (Passive) Selection Using the Function Menu.....	73
Figure 56 - Direct Resistance Selection Keys.....	74
Figure 57 – Resistance (Passive) Selection Using the function Menu.....	75
Figure 58 - Soft Key and Direct Touch Selection of 4-Wire Mode.....	75
Figure 59 – Direct Capacitance Selection Keys.....	77
Figure 60 - Capacitance (Passive) Selection Using Function Menu.....	78
Figure 61 – Capacitance (Simulated) Using Function Menu.....	80
Figure 62 – Direct Inductance Selection Keys.....	81
Figure 63 – Inductance Selection Using Function Menu.....	82
Figure 64 – Thermocouple Simulation Menu.....	83
Figure 65 – Direct Frequency Selection Keys.....	87
Figure 66 – Frequency Selection Using Function Menu.....	87
Figure 67 – Soft Key and Direct Touch Selection of RPM Values.....	89
Figure 68 – Soft Key and Direct Touch Selection of Simulated Ohms.....	92
Figure 69 - AC Power Menu Screen.....	95
Figure 70 – Soft Key and Direct Touch Selection of AC Power Options.....	96
Figure 71 – Phase Correction Indicator.....	96
Figure 72 – DC Power Menu Screen.....	97
Figure 73 – Voltage Waveform Selection Screen.....	100
Figure 74 – Soft Key and Direct Touch Selection for Oscilloscope Options.....	101
Figure 75 - Amplitude Mode Screen.....	102
Figure 76 - Timebase Mode Screen.....	102
Figure 77 - Bandwidth Mode Screen.....	103
Figure 78 - 4000 Main Screen.....	109
Figure 79 – Selecting Verification Procedure.....	109
Figure 80 – Pre-Test prompt display toggle.....	110
Figure 81 – Enable adjustment toggle.....	110
Figure 82 - Procedure Mode Screen.....	110
Figure 83 – Procedure Mode Pre-Test Prompt.....	111
Figure 84 – Verification Mode Measurement Screen.....	112
Figure 85 – Verification Mode Summary View.....	114
Figure 86 – Compound Command Schema.....	118
Figure 87 – Underside of 4000 Series Calibrator.....	166
Figure 88 – Top Board With Cover.....	168
Figure 89 - Fuse Location on Top Board With Cover Removed.....	169
Figure 90 – Fuse Location on Front Panel PCB.....	169

## LIST OF TABLES

Table 1 - Keyboard Functions .....	28
Table 2 - Main Menu Options.....	34
Table 3 - Configuration Options .....	36
Table 4 - Terminal Descriptions .....	51
Table 5 - Thermocouple Functions .....	84
Table 6 - Scope Options .....	103
Table 7 – Supported Reference Multimeters .....	107
Table 8 – Verification Screen Components.....	112
Table 9 – 4000 Series Response / Error Code Description .....	116

# 1 Introduction



**Figure 1 - The 4010 Advanced Multiproduct Calibrator**

The 4000 series calibrator offers the most advanced and up to date means of calibration of a wide variety of electrical measuring instruments. The 4000 series advanced multi product calibrator provides a fully functional, precision programmable calibration source.

## 1.1 Main Features

- AC/DC Volts to 1025 V
- AC/DC Current to 30 Amps
- AC/DC Current to 1500 Amps with EA002 50 Turn Clamp Coil Adapter
- 2 and 4 Wire Resistance to 1 G $\Omega$  (passive and simulated modes)
- Capacitance to 100 mF (passive and simulated modes)
- Inductance to 10 H
- Frequency to 10 MHz
- Pulse Width Modulation / Duty Cycle
- PT100 resistance Simulation (Option)
- RTD Simulation active (Option)
- Thermocouple Simulation ( $^{\circ}\text{C}$  &  $^{\circ}\text{F}$ )

- DDS Power / Power Harmonics Generation (Internal Option)
- 350/620 MHz Oscilloscope Calibration (Internal Option)
- 6400MHz High Bandwidth Oscilloscope Output
- USB Interface
- GPIB (IEEE488) Interface Option
- Extendable via Range of Adaptors utilising the Adapter Interface

## 1.2 Accuracy and Functionality

The 4000 series integrates powerful calibration capabilities using built-in software. This system provides total functionality including procedure management, calibration record keeping and built-in PCL printer connectivity for direct printout of reports. The 4010 advanced multi product calibrator has a basic DC accuracy of 8ppm.

## 1.3 True Multiproduct Calibration

### ***From one instrument***

Designed to provide an accurate cost effective instrument for the calibration of multimeters, clamp meters, frequency meters, temperature meters, and capacitance meters. Internal options allow the calibration of power meters, oscilloscopes up to 6.4GHz, inductance and LCR meters.

Designed for use in the laboratory or portable onsite calibration, the 4000 series calibrator is suitable for use in a standards laboratory. The 4000 series boasts a fast warm up time combined with direct connection to a PC/laptop (via a USB interface) allowing for a fast return on investment and premium accuracy.

## 1.4 Retro Fit Options

***Allows additional functions to be added.***

Several internal retrofit options including oscilloscope, power, inductance and PRT allow the user to select the most cost effective solution for the calibration work with the ability to add extra functions at a later date. External options for the calibration of clamp meters, high accuracy thermocouple simulation with auto CJC (cold junction compensation) built into the TC (thermocouple) connector, optical tachometers, torque drivers etc. are also available via the front panel adapter interface.

## 1.5 USB Interface

***Fitted as standard.***

All functions and outputs of the 4000 series calibrator are fully programmable over the USB interface. The use of the USB interface saves the cost of fitting GPIB cards to the PC, and also allows easy connection to portable PC's, reducing the set up time for on-site calibration.

## 1.6 Output Connections

The output terminal configuration is designed to match the majority of multimeter input connections, e.g. volts/ohms, low current and high current eliminating the need for lead changing during calibration. All outputs are isolated when not in use and an L.E.D. indicator shows the active output(s).

## 2 Preparing The Calibrator for Use.

### 2.1 Initial inspection

After shipment the calibrator should be inspected for any signs of external damage. Should external damage be found contact the carrier immediately. Do not connect a damaged instrument to the line power as this may result in internal damage. Please retain the original packaging; this should be used when returning the calibrator for service and recalibration.

### 2.2 Lifting and Carrying the Calibrator

*Note:*

*Observe all normal practices for health and safety when carrying heavy items.*

The calibrator weighs 23kg with most of the weight at the right rear corner. The calibrator can be carried by one person supporting the underneath. The front handles, fitted as standard, can be used to move the calibrator short distances or to reposition. A custom carry case with shoulder strap is available if the calibrator is to be regularly transported - see options list. The calibrator should always be placed down on a firm flat surface on its base feet. Avoid knocking or banging the calibrator and always place down smoothly.



***Warning: DO NOT DROP THE CALIBRATOR***

*This may cause internal damage.*

## 2.3 Positioning the Calibrator

The calibrator can be used free standing on a bench or mounted in a standard rack enclosure. The calibrator can be operated at any angle; the two front feet have tilt legs for bench operation. For all installations care must be taken not to cover the ventilation slots underneath or block the fan. A 2" (5cm) space behind the instrument is also required for line and interface connections.

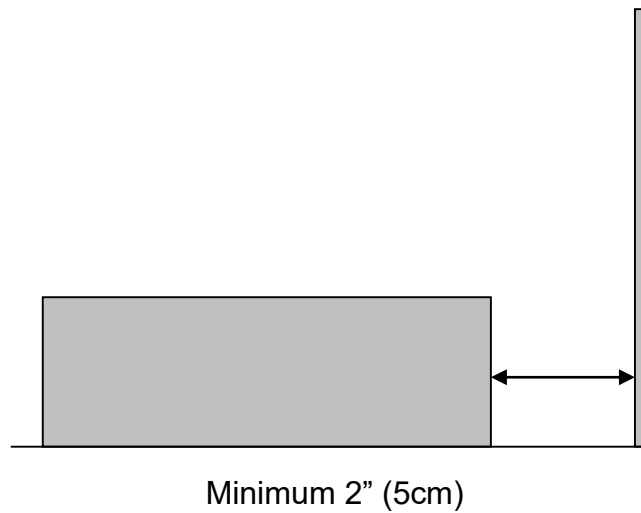

**Figure 2 - Minimum Clearance Required**



## 2.4 Rear Panel Connections and Controls

Connections on the rear panel are for Line Power via a 3 Pin IEC connector incorporating the Line Fuse, Voltage Selection and on-off switch. Note the mains inlet is filtered.

A USB Type B socket is provided for connection to computers for remote control of the calibrator through software.

In addition, an optional GPIB Interface can be installed to allow remote control of the 4000 Series via GPIB.

An additional GPIB interface for connection of a reference Multimeter that does not offer USB or Serial connectivity can also be specified.

A third connector for the 10kV External HV amplifier (EA3024) is also provided if the option is specified.

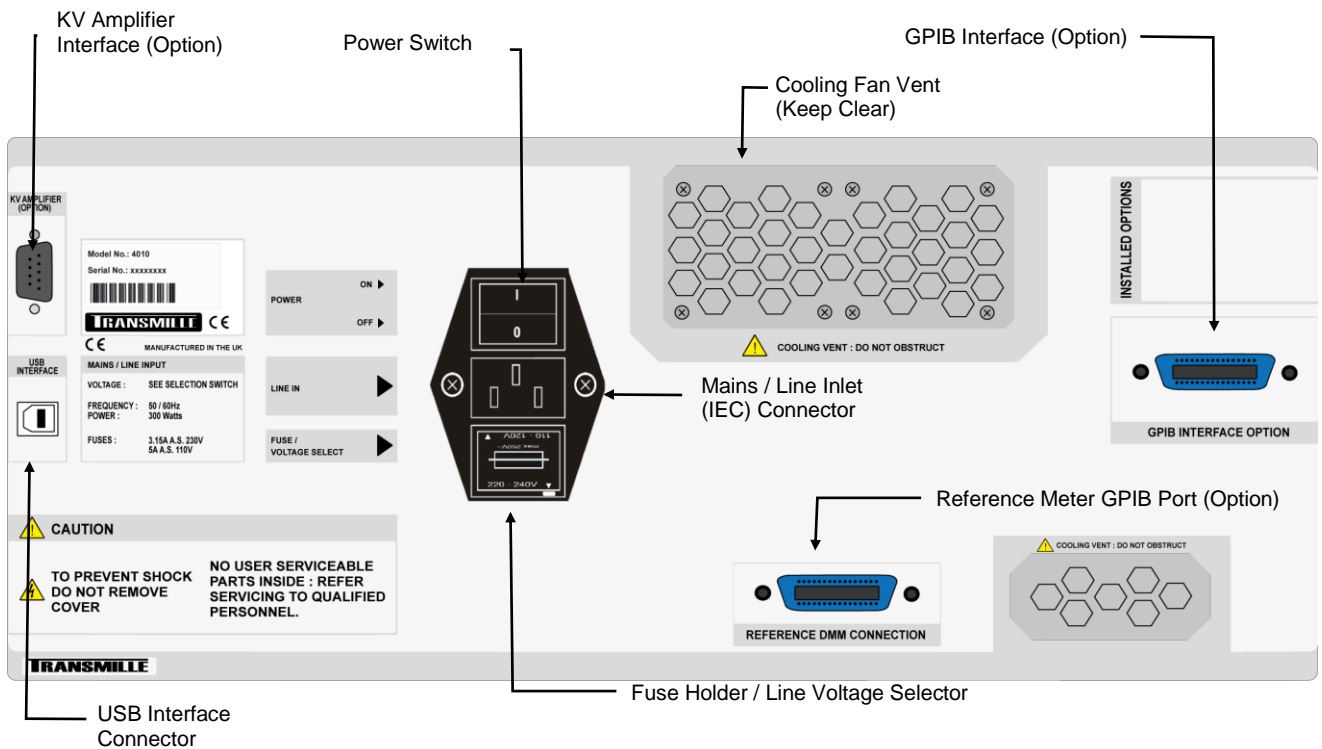

Figure 3 - Rear Panel Connections and Controls

## 2.5 Setting and checking the Line Voltage



*Warning: The line power cord must have an earth conductor to avoid risk of shock.*

*This instrument must be correctly earthed.*

The calibrator has been designed to work from either 100-120 Volt line supply or 200 - 240 Volt line supply. Check that the voltage selector is set at the correct voltage before connecting the power to the instrument. Connecting the calibrator to the wrong supply will cause internal damage to the instrument. To change the line voltage, remove the fuse / voltage selector housing, rotate through 180° and replace with the required voltage setting at the bottom of the housing indicated by the arrow, ensure that the correct fuse is fitted. The calibrator is set for 110V operation in the USA, 230V operation in the UK and Europe.

Options for 100V operation in Japan are available (option must be ordered).

## 2.6 Power Line Inlet Fuse and rating

The power line inlet fuse is located directly below the power inlet within the voltage selector housing. The correct fuse rating is 3.15A anti-surge for 230V operation and 5A anti-surge for 110V operation.

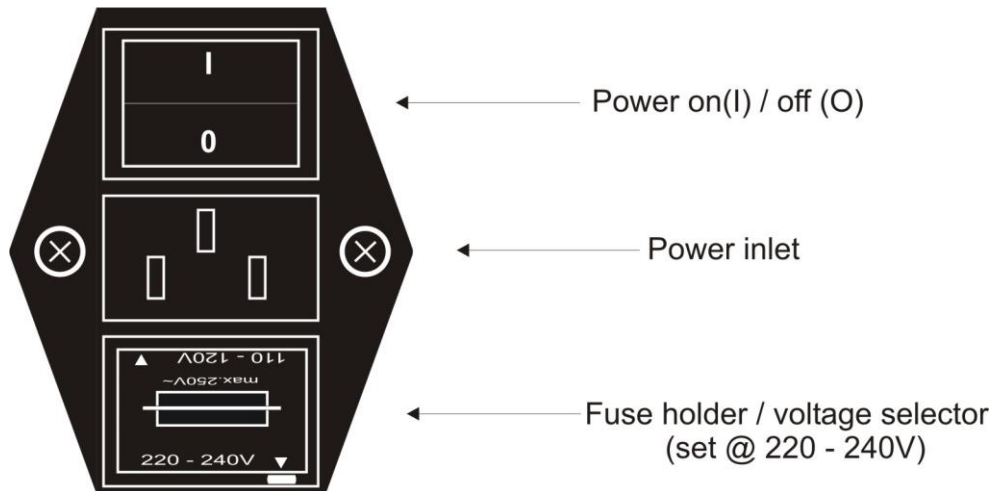

**Figure 4 - Power Line Fuse**

## 2.7 Interface Types

Connection to the 4000 Series calibrators is achieved by the following interfaces:

- **USB**

Using supplied USB cable. If a longer / replacement cable is required, the 4000 Series requires a USB 2.0 Type A to Type B cable.

- **GPIB (option)**

Requires GPIB cable for connection to PC.

## 2.8 USB Interface

The 4000 series calibrator can be fully controlled and calibrated via USB interface. The interface is optically isolated from the calibrator circuitry. The calibrator can send information with reference to the output status, calibration factors and value of internal standards together with other information. The internal processor decodes the commands and returns control codes to verify the correct operation of that command.

The calibrator can be sent individual commands directly from a Windows HYPER TERMINAL program, any basic or high level program, or from the ProCal Calibration System.

## 2.9 Connecting to a computer

A USB cable (supplied) can be used to connect the calibrator to a computer via a USB Port.



**Figure 5 - USB Cable Connection from PC to Instrument**

Also supplied is a USB driver on CD:



Figure 6 - Supplied USB driver

For details on installing the USB driver, see appendix A.

## 2.10 Powering up the calibrator

After connecting line power, the calibrator can be switched on with the line power switch above the mains inlet socket on the rear panel.

The fan will start and the front panel display will illuminate indicating power. The display will show the Transmille logo and state that it is initialising.

After a short delay, during which time the processor performs a self-test of the instrument, the display will show an output of 000.00000mV DC.

Allow the calibrator to warm up for 30 minutes to obtain full accuracy; the fast start feature of the calibrator will give approx. 90% of full specifications within 10 minutes. The calibrator has been designed to be powered up continuously.

If the calibrator is being used using a remote interface, the control program can be run once the calibrator has fully initialised.

## 2.11 Output Connections



*Warning: Risk of shock.*

*High voltages may be present on the output binding posts.  
Ensure calibrator is in the STANDBY condition  
before changing leads or connections.*



*For voltages greater than 30V AC RMS, 42V AC Peak or 60V DC,  
the binding posts must be in the closed position.  
ONLY 4mm banana connections should be used for  
outputs above these voltages.*



*Do not touch exposed metal on banana plugs, spade connections  
or bare wires. These outputs may have  
lethal voltages present*



*Warning: Under no circumstances should any voltage  
be connected to the calibrator outputs.*

*Although the output terminals are protected against voltage/current  
being applied, repeated application of voltage/current may affect the  
performance and reliability of the protection circuitry.*

Output binding posts are all low thermal tellurium copper 4mm binding posts. The binding posts accept 4mm style connectors, as well as spade and bare wire connections when the binding post is in the open position.

Additional Outputs (Oscilloscope, Frequency) are either BNC or Type N connections.

The 4000 series calibrator's outputs have been designed to allow most multimeters to be calibrated without changing connections. There are 7 separate 'sets' of binding posts that will be used for outputs

- 1) AC / DC Voltage, 2 Wire Resistance, Capacitance & Inductance
- 2) AC / DC Current up to 2A and 4 Wire Resistance
- 3) AC / DC Current above 2A.
- 4) Scope Output Terminal
- 5) Frequency Output Terminal
- 6) High Bandwidth Output Terminal
- 7) Earth Terminal

When an output terminal pair is not active they are completely open circuit (except High Bandwidth and Earth Terminal) and isolated from the other outputs. As only one pair is active at a time (except 4 wire Ohms and Passive PRT Output) they may be combined together if required to match the meters input arrangement.

The Earth Terminal is always connected to earth via the earth pin on the IEC connector on the rear. The earth terminal can be used to connect a floating instrument under test to a common ground.

*Note:*

*To avoid ground loops, do not connect the front panel Earth Terminal to ground. The Earth Terminal is always connected to earth via the rear panel IEC terminal*

One example is the configuration of multimeter inputs with a single common low and inputs with voltage, low and high current. To match this to the calibrator, simply connect the 3 low outputs of the calibrator together and connect the voltage, low & high current outputs to the appropriate meter's inputs. Note that when outputting resistance, the calibrator will use the voltage output terminals.

A second example is where the meter has separate voltage and current inputs, often using four wire ohms on both pairs. In this case simply connect the voltage and

current outputs to the meter's inputs, the calibrator will use both the voltage and current pair on 4 wire ohms.



It is recommended that the voltage and low current leads be of high quality screened cable with gold plated 4mm plugs fitted. The cable must be able to withstand 1025 volts AC and have an insulation resistance greater than  $1T\Omega$  to avoid introducing any shunting effect on the high resistance ranges.

Poor quality test leads will introduce noise, thermal E.M.F. and leakage errors on low voltage & current ranges and also unstable readings on resistance and capacitance outputs. Special test leads are available from Transmille.

The low output can be connected to line earth or allowed to float as selected - see operation section of this manual. It is recommended that the low is earthed which will help to reduce noise on high ohms and low current. If allowed to float with respect to line earth the low must remain within 50 volts of line earth. Outputs are optically isolated from the USB and GPIB interfaces

## 2.12 Warning and output Overload indications.

The self-test function of the 4000 series calibrator continuously monitors the output of the calibrator for overload or fault conditions.

In the event of the calibrator not being able to drive the load, it will automatically trip into standby and the display will show . The required drive current being too high on a voltage range, or the required compliance voltage being too high on a current range causes the 'standby' condition. Pressing the  key after the load has been corrected can restore the output.



## 2.13 High Voltage Timeout.

As an additional safety feature, the calibrator will automatically return to standby if left on the 200V or 1kV ranges after a set time period. This is 20 minutes for DC and AC frequencies of less than 5 kHz or 3 minutes for frequencies of 5 kHz and greater.

This feature is ENABLED as a default setting when instruments are shipped from Transmille, however can be disabled by the user.

## 2.14 30 Amp Temperature Cut-out

The 4000 series calibrator is capable of supplying high currents for sustained periods of up to 30A. Above this value the calibrator will enter a standby / cool-down period until the instruments temperature has reduced. The output amplifier operating temperature is monitored by the micro controller, which will shut down the output if required. The time before shut down occurs will vary depending on the set output current and the load - see extended specifications. During this shutdown period, the calibrator will be set to standby with a warning message shown on the display indicating the temperature limit has been reached. It is safe to reselect the output at any time as the microprocessor will automatically protect the output amplifier from damage.

## 3 Operation

### 3.1 Safety Warnings



*WARNING: The information in this section is intended only for qualified personnel. The user must at all times be adequately protected from electric shock. Qualified personnel must ensure that operators of the equipment are adequately insulated from connection points.*



*WARNING: This instrument is capable of generating both DC and AC high voltages.*



*Soft carry-cases and hard transit cases are available for regular transportation of the calibrator.*

### 3.2 Introduction to Operation

All functions of the 4000 Series Calibrator can be controlled from the front panel soft keys, touch screen interface or controlled remotely by a computer. During remote control the front panel is 'locked out', but local control may be resumed by pressing the 'local' button - it must be remembered that this action may disrupt the computer program.

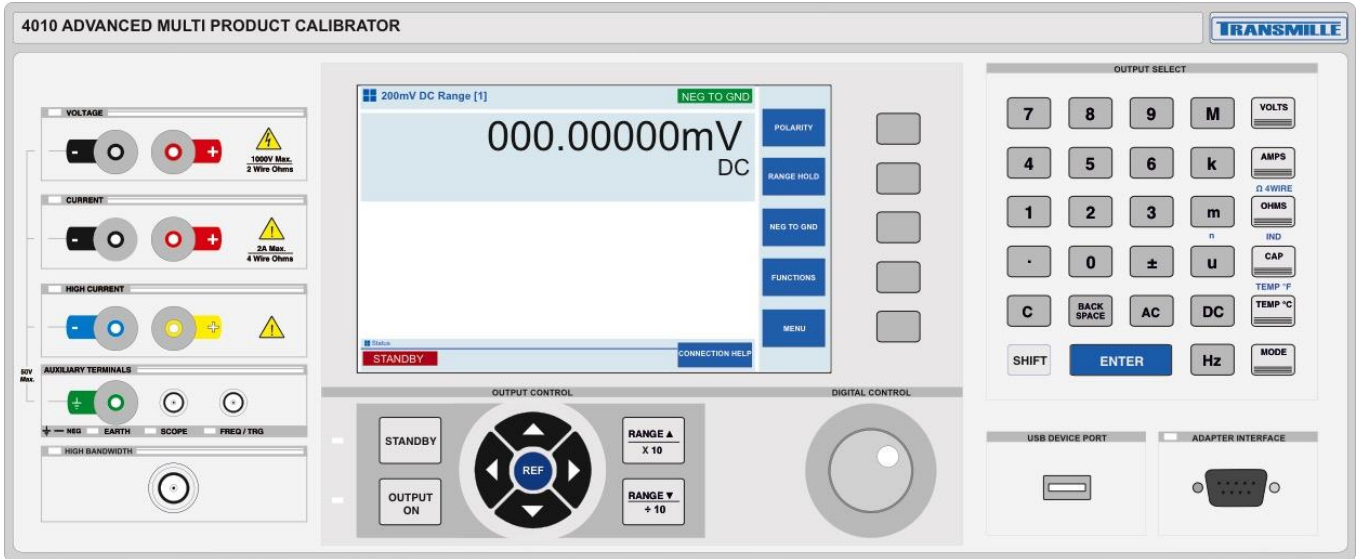

**Figure 7 - 4000 Series Front Panel**

### 3.3 Front Panel Controls

The front panel of the 4000 Series Calibrator utilises a high quality custom rubber keyboard with tactile feel buttons and integrated touchscreen interface. The front panel is therefore sealed against the ingress of moisture and dirt enabling the calibrator to be used in most working environments without risk of early failure of the operating buttons. The front panel can easily be wiped clean with a soft cloth. Care should be taken not scratch the touchscreen interface. All graphics are 'under printed' making them rugged and durable.

*Note:*





*The front panel key buttons are for use with fingers only - do not press the key with hard or sharp objects e.g. Ball-point pens, pencils, screwdrivers etc. Repeated actions like this will almost certainly cause the keyboard to fail. (This will not be covered under warranty). Care should also be taken when transporting the instrument, do not place test leads or other objects on top of the panel which may come into contact with the display area and cause damage.*

*Note:*

*The touchscreen offers a capacitive touch capability. This means that a stylus is not required to operate the screen. Hard or sharp objects e.g. Ball-point pens, pencils, screwdrivers etc. should not be used to enter parameters on the screen. The screen will not operate if a glove is worn over the operating hand, in cases where this is unavoidable the physical soft keys can be used to select functions as opposed to utilising the touchscreen. Please note that the warranty DOES NOT cover damage caused to the touchscreen by using objects other than fingers to use the touchscreen interface.*

The keyboard is divided into sections to allow easy operation. These sections are displayed below:

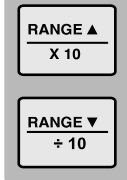
**Table 1 - Keyboard Functions**

<p style="text-align: center;"><b>Numerical Keypad</b></p> <p style="text-align: center;">Allows numeric values to be entered.</p>	
<p style="text-align: center;"><b>Multiplier Keys</b></p> <p style="text-align: center;">Mega (M), kilo (k), milli (m), micro(u) or nano (n).</p>	
<p style="text-align: center;"><b>Function Keys</b></p> <p style="text-align: center;">Volts (V), Amps(A), Ohms (2 &amp; 4 Wire), Farads(F), Celsius(C), &amp; Frequency(Hz).</p>	
<p style="text-align: center;"><b>Range Up / Range Down Keys</b></p> <p style="text-align: center;">Allow the output to be multiplied / divided by 10.</p>	
<p style="text-align: center;"><b>Left / Right / Up / Down Arrow Keys</b></p> <p style="text-align: center;">To select the digit to be controlled by the rotary control.</p>	

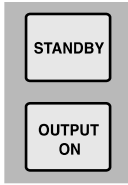
<p style="text-align: center;"><b>Output On / Standby keys</b></p> <p>Allow the calibrators output to be disconnected from the terminals. LED indicators are incorporated in these switches to clearly show the output status.</p>	
--	---

### 3.4 Digital Control

A digital potentiometer allows the 'highlighted digit' on the display to be incremented (turning clockwise) or decremented (turning anti-clockwise). As an output is changed the deviation from the original value entered on the keyboard is shown in either % or ppm, depending upon the magnitude of deviation from the previous set point.

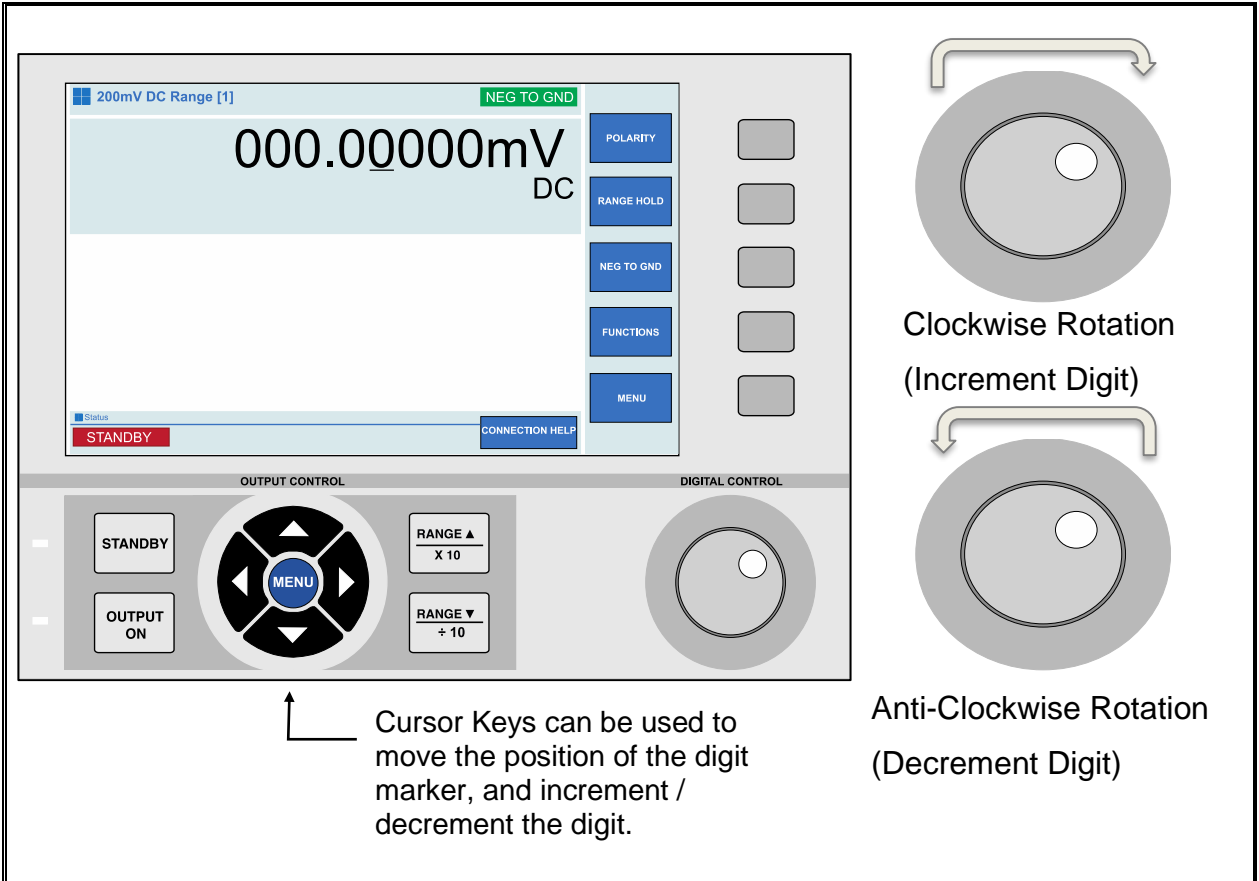

Cursor Keys can be used to move the position of the digit marker, and increment / decrement the digit.

**Figure 8 - Front Panel Digital Control**

## 3.5 Front Panel USB Connector

The 4000 Series features a Front Panel USB (USB 2.0 Type A) connector for connecting USB Printers (must be PCL compatible) and USB Sticks.

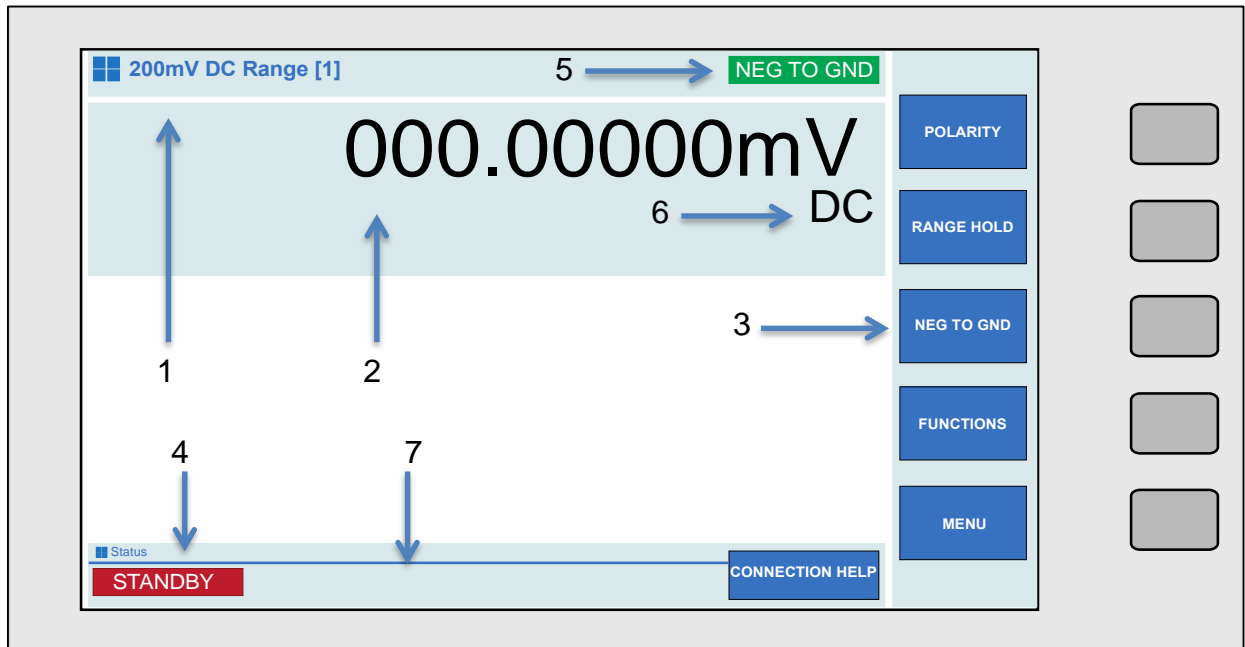

**Figure 9 – USB Device Port**

The 4000 Series has the ability to read and write files to memory sticks connected to the USB port, and is used to apply Firmware Updates and upload new procedures and connection images to the unit. It is also used to download test reports and calibration data.

## 3.6 Touchscreen Interface Functionality

The touchscreen interface provides additional control alongside the keyboard functionalities. The 7-inch LCD display shows the present output, instrument status, % or ppm change from the entered value, and also the new value being entered. The right hand portion of the display is used to assign the function of the five soft keys (these functions can be directly touched to activate as well). A 'connection help' button is also located at the bottom of the LCD display. This provides detailed user assistance in the form of connection schematics for each type of measurement. The touchscreen features are shown in Figure 10



**Figure 10 – 7 Inch High Resolution LCD Touchscreen**

1. Output range and function
2. Output value
3. Dynamic soft key and direct touch menu
4. Instrument status indicator
5. Negative to Ground indicator
6. Function specific configuration display
7. Error Message Indicator
8. Connection Help



### 3.7 Connection Help Prompts

To ensure ease of use, the 4000 Series Calibrator features inbuilt connection help prompts which can be displayed on the screen. These prompts are designed to assist with making connections to typical test equipment.

Connection prompts are function specific, and the correct prompt is displayed automatically for the function selected (i.e. a connection prompt suitable for DC Voltage will be displayed when in the DC Voltage function).

To view the connection prompt, press the 'CONNECTION HELP' key in the lower right of the main output screen (highlighted in Figure 10 on Page 32). A full screen colour image of an example connection will appear on the screen

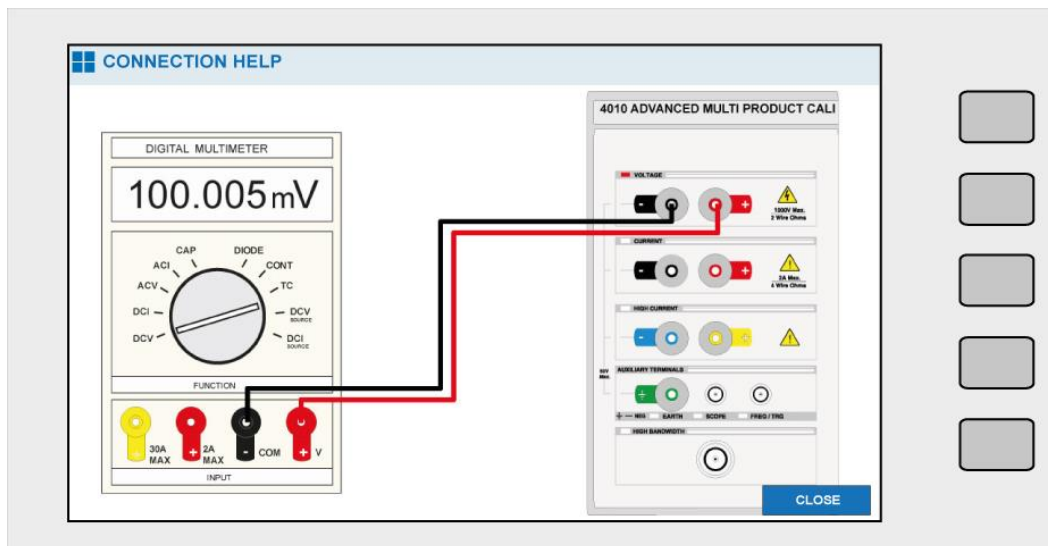

**Figure 11 – Connection Help Screen**

Connection prompts can be updated via the USB connection while performing a Firmware Update to custom images for specific applications.

To leave the connection help screen, press the 'CLOSE' button in the lower right of the screen.

*Note:*

*The output of the calibrator will remain active during display of a connection prompt.*

## 3.8 Main Menu

The 4000 series calibrator provides a host of easily accessible configuration and service options including procedural, calibration, test report, language, passcode and firmware among others. These options will be briefly discussed below.

To enter the menu page, press the 'MENU' soft key or touch button whilst on the main output screen.

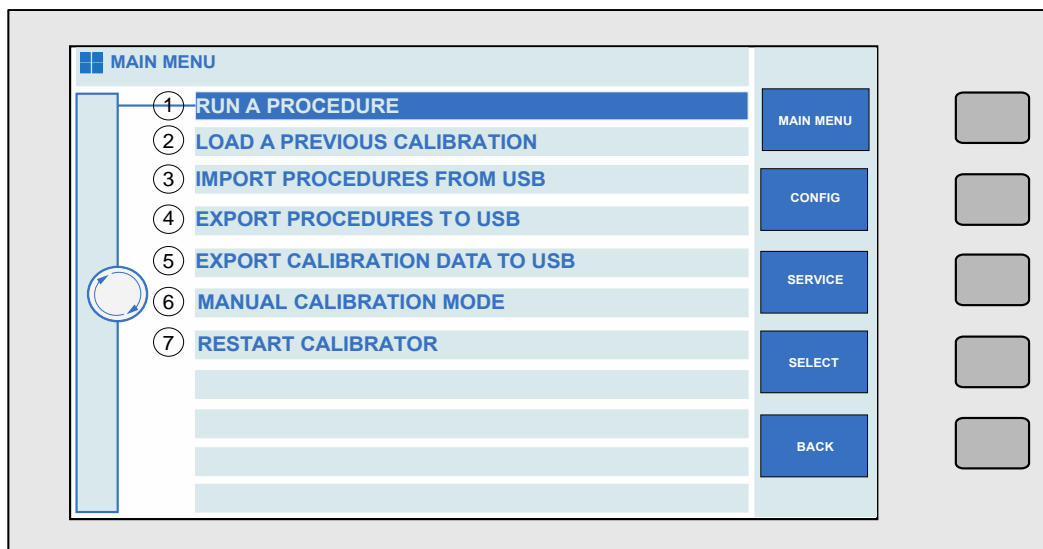

Figure 12 - Main Menu Screen

Table 2 - Main Menu Options

### 1 Run a Procedure

This option is used to run a pre-loaded procedure. Procedures can be imported and exported via USB.

### 2 Load a Previous Calibration

This option allows the user to view a test report of a previous calibration. Within this function you can print the report, save data or select a test to view or resume testing (via the menu key).

### **3 Import Procedures from USB**

Use this option to import procedures to the calibrator from a USB storage device.

### **4 Export Procedures to USB**

Use this option to export procedures from the calibrator to a USB storage device.

### **5 Export Calibration Data to USB**

This option allows the export of calibration data to a USB storage device.

### **6 Manual Calibration Mode**

This option allows the user to manually calibrate the calibrator via the touchscreen. This option is password protected and the user will be prompted to enter the password upon selecting this mode. Please refer to the 4000 Series Calibration Manual for further details of this function.

### **7 Restart Calibrator**

If, for unexpected reasons, the calibrator requires restarting, this function can be used. Upon restarting the calibrator, the default DC volts screen is displayed.

## 3.9 Configuration Menu

To enter the Configuration Menu, follow the instructions in Section 3.8 to access the Main Menu. Whilst on the Main Menu, press the 'CONFIG' soft key or touch button to enter the configuration menu.

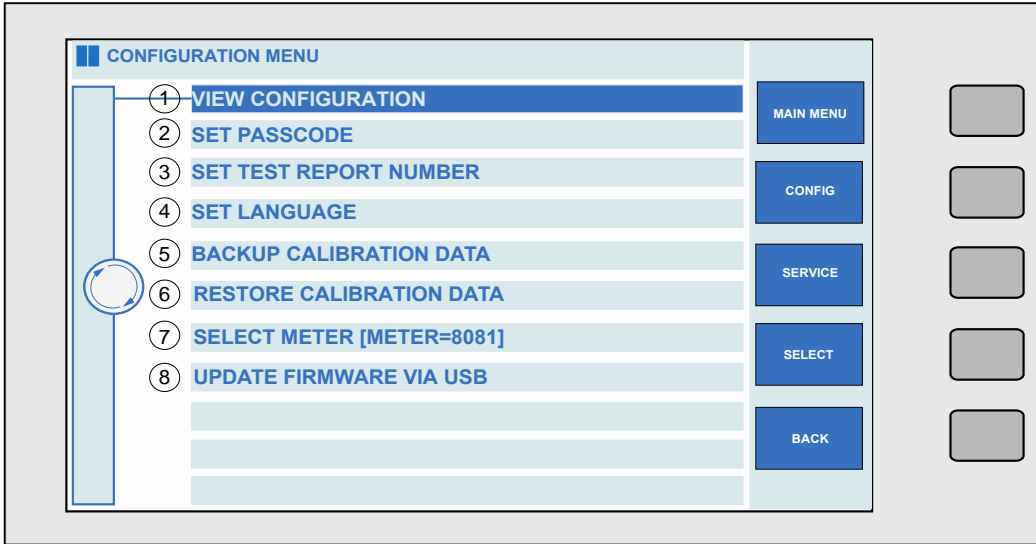

**Figure 13 - Configuration Screen**

**Table 3 - Configuration Options**

<p><b>1</b></p> <p><b>View Configuration</b></p> <p>Select this option to view your current configuration settings.</p> <p><b>2</b></p> <p><b>Set Passcode</b></p> <p>Select this option to set a passcode, using the numerical keys to lock calibration functions.</p> <p><b>3</b></p> <p><b>Set Test Report Number</b></p>
--

Using this function to select the current test report number

**4 Set Language**

Use this option to change the language displayed on the calibrator.

**5 Backup Calibration Data**

This option allows calibration data to be backed up.

**6 Restore Calibration Data**

This option allows the user to restore calibration data.

**7 Select Meter**

Enables selection of the reference Multimeter to be used for self-verification / adjustment tests

**8 Update Firmware Via USB**

Select this option to update firmware (when available) via USB.

### 3.10 View Hardware Configuration

The 'View Configuration' menu option allows users to view the hardware and software configuration of the 4000 series calibrator, as well as the serial number of the unit.

To view the configuration of the unit, select the 'VIEW CONFIGURATION' menu item.

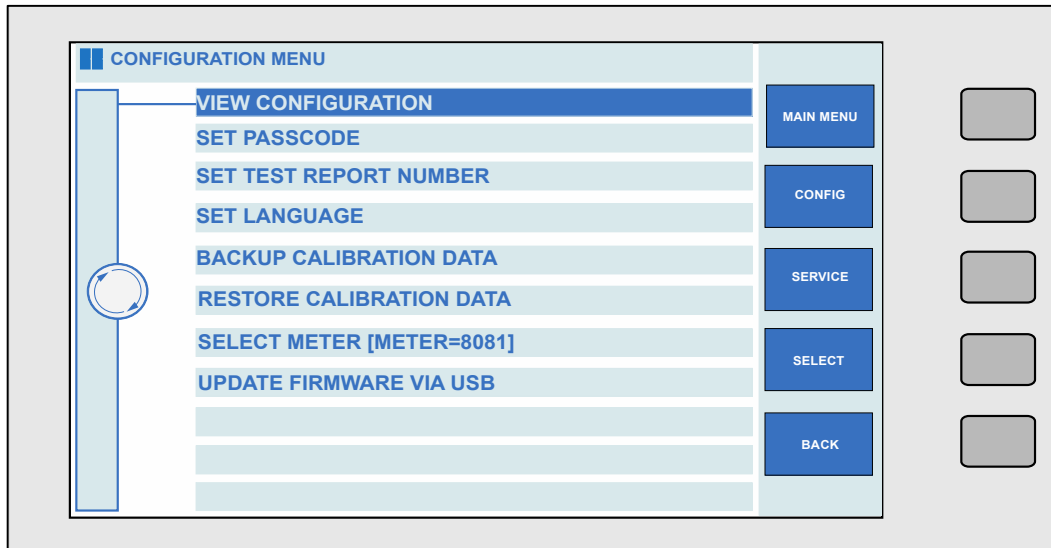

**Figure 14 – Configuration Menu**

Upon selecting the menu item and pressing 'SELECT' or 'ENTER', a prompt will appear displaying the configuration of the unit.

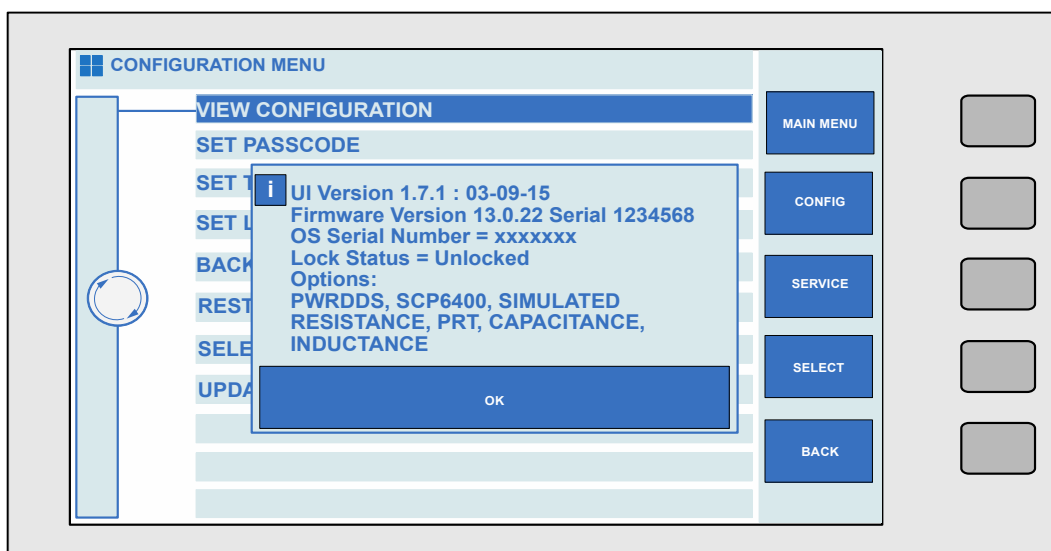

**Figure 15 – Unit Configuration prompt**

## 3.11 Set Passcode

The 4000 Series calibrator has the ability to lock configuration options to prevent unauthorised changes to settings or configurations.

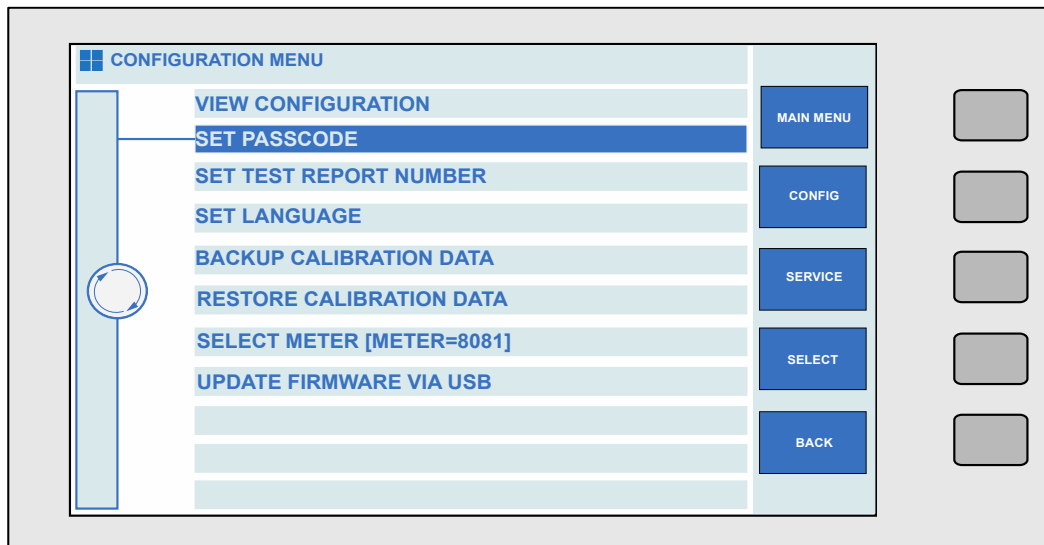

**Figure 16 – Set Passcode Selected**

To modify the Passcode, first select 'SET PASSCODE' from the Configuration Menu.

Pressing the 'SELECT' key, or pressing 'ENTER' will display a prompt enabling entry of a new passcode.

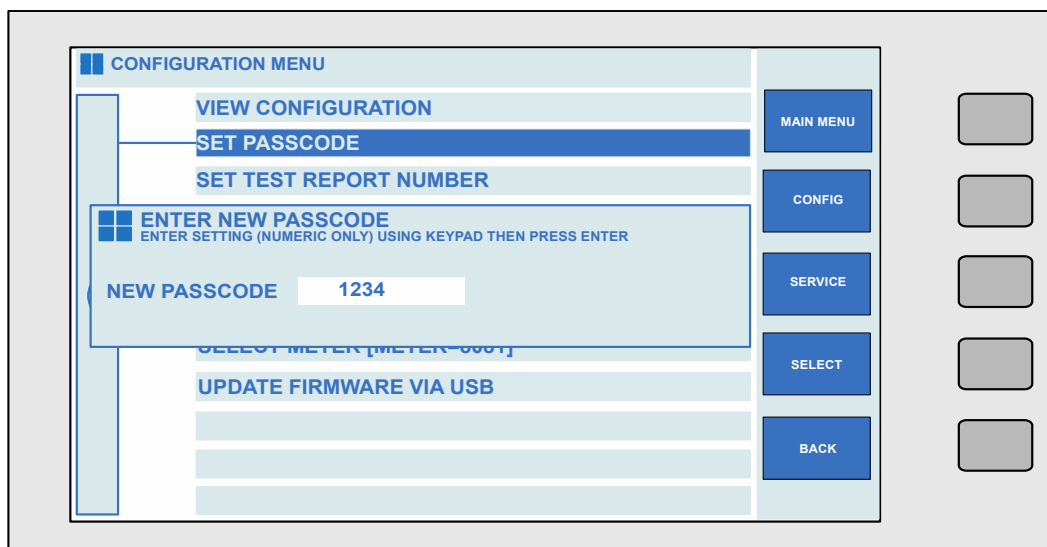

**Figure 17 – Enter New Passcode Prompt**

Using the Numerical Keys (Section 3.3), enter the desired code. Pressing the 'ENTER' key will confirm your entry, which will be confirmed by the calibrator.

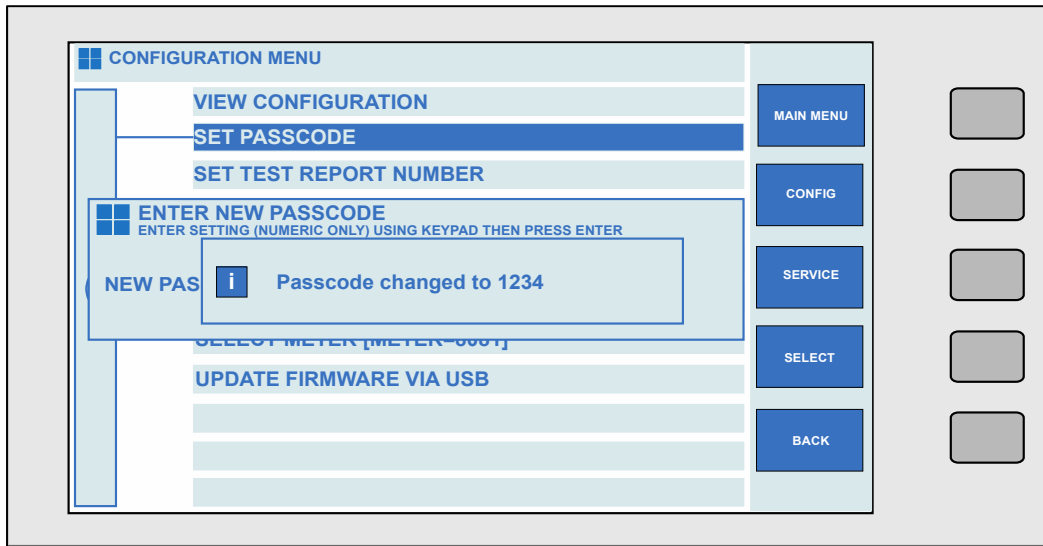
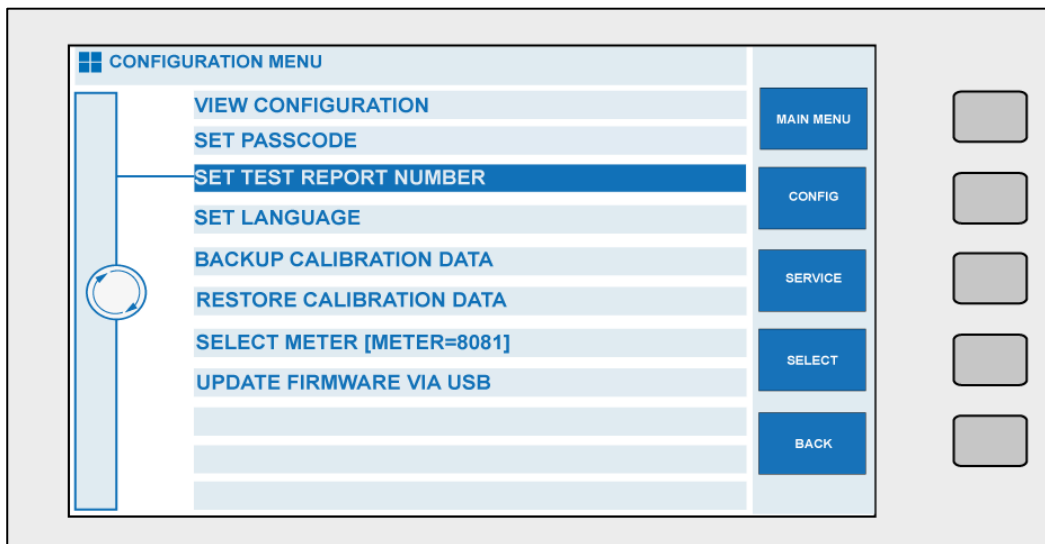

**Figure 18 – Confirmation of change to Passcode**

### 3.12 Configuring Test Report Number

To adjust the test report number that the 4000 series assigns to test procedures, the Configuration Menu can be used to set a new starting number. This will then be automatically incremented each time a new test procedure is saved.

To modify the Test Report number, first select 'SET TEST REPORT NUMBER' from the Configuration Menu.





### Figure 19 – Set Test Report Number selected

Pressing the 'SELECT' key, or pressing 'ENTER' will display a prompt enabling

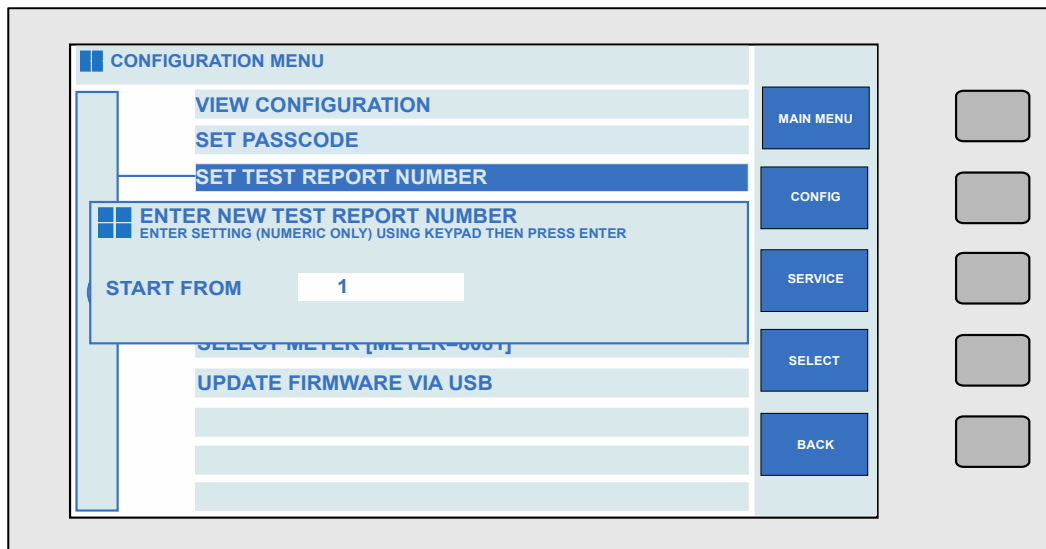

entry of the new Test Report Number

### Figure 20 – Enter New Test Report Number Prompt

Using the Numerical Keys (Section 3.3), enter the desired code. Pressing the 'ENTER' key will confirm your entry, which will be confirmed by the calibrator

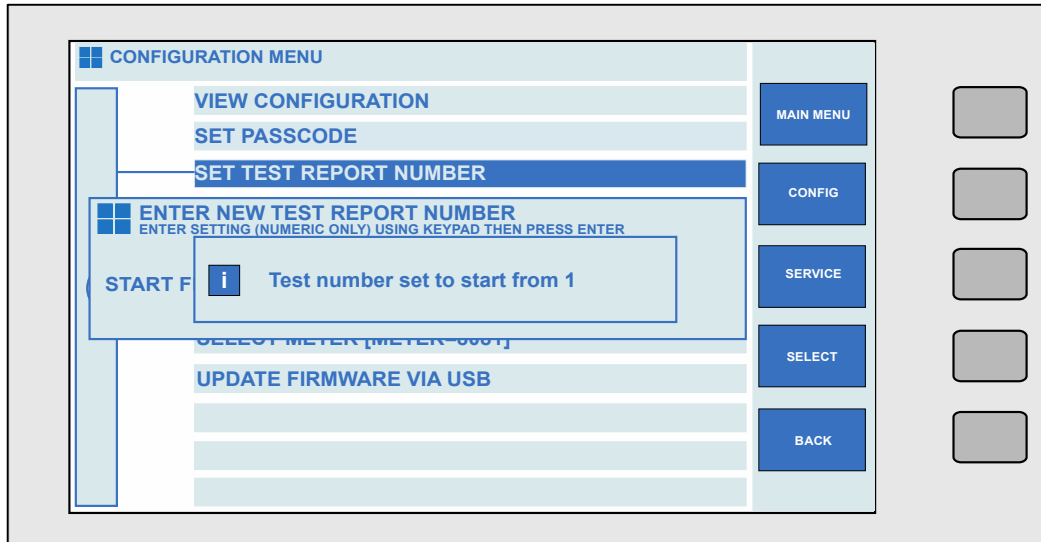

Figure 21 – Confirmation of change to Test Report number

### 3.13 Configuring Reference Multimeter

The 4000 series has the ability to self-verify using an external reference multimeter for full traceability.

To configure communication with an external multimeter, the model and address (GPIB only) must be configured.

The default condition is to connect to a Transmille 8081 via the front panel USB port, however an option is available to add an additional GPIB port to the rear panel for connection to multimeter that offer only GPIB interfaces.

*Note: To avoid address conflicts on the GPIB bus, the GPIB controlled reference meter MUST be connected to the correct GPIB connector.*

To select the model and address of reference meter, highlight the 'SELECT METER' menu option in the configuration menu

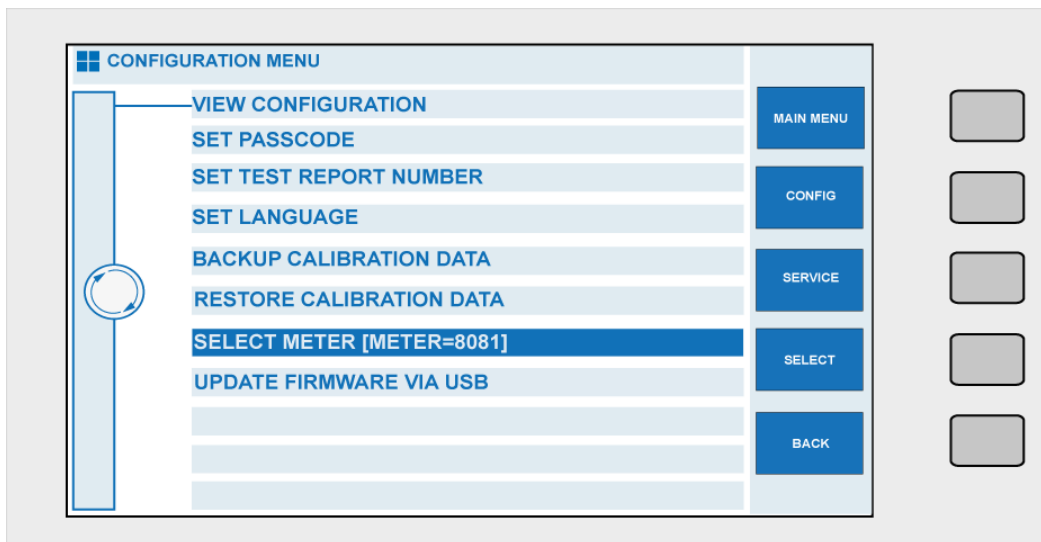

**Figure 22 – Reference Meter Selection**

Press the 'SELECT' soft key or the 'ENTER' key to access the meter configuration menu. Using the Digital Control or the arrow keys, select the required multimeter by highlighting the selection and then pressing 'SELECT' or using the 'ENTER' key

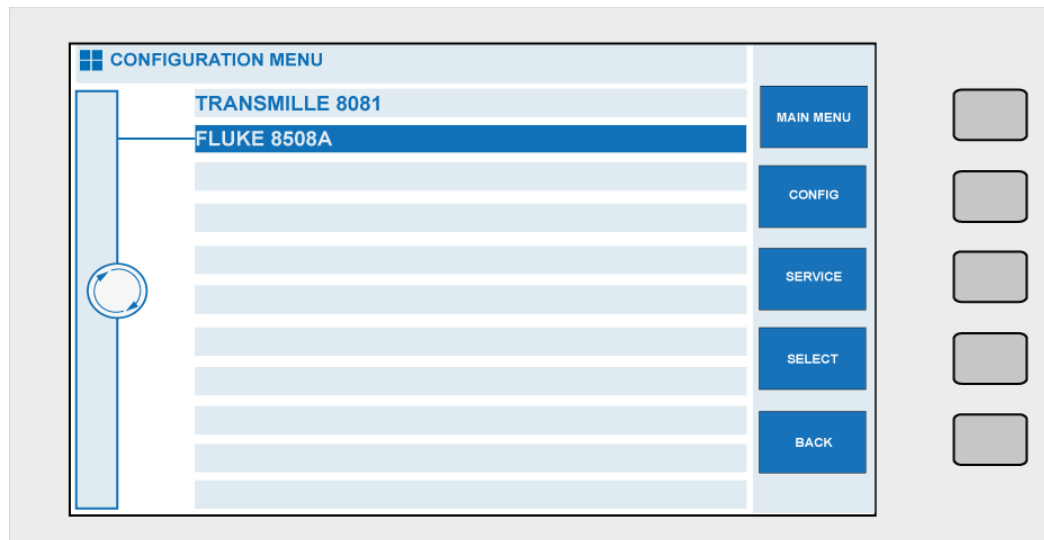

**Figure 23 – Reference Meter Configuration Menu**

In the case of the Reference Meter GPIB option being installed, and a meter that offers only GPIB connectivity has been selected an additional menu will appear prompting the user to enter the GPIB address of the reference multimeter.

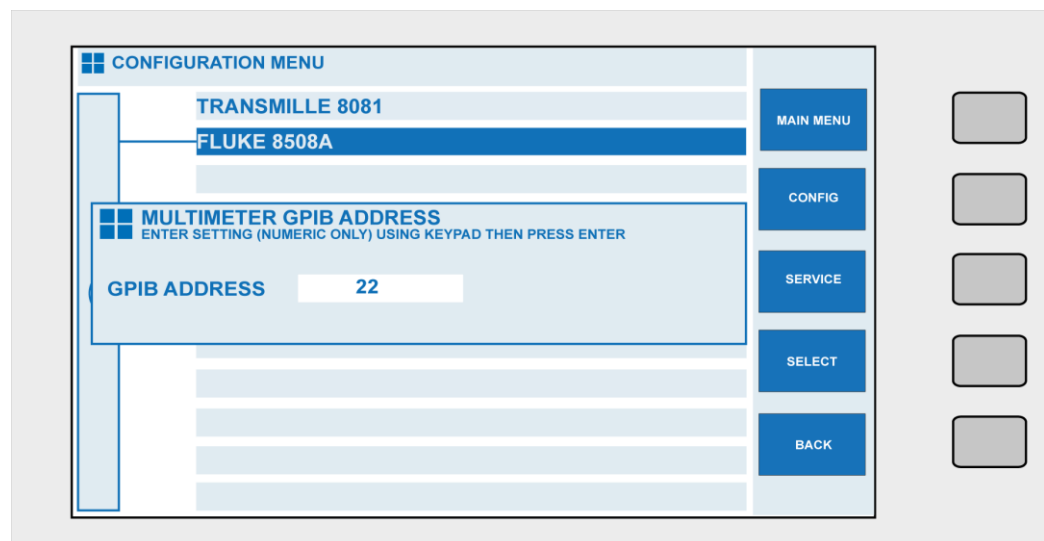

**Figure 24 – Reference Meter GPIB Address Entry**

*Note: The 4000 series supports GPIB addresses between 1 and 30*

*Note: The Reference meter port acts as a GPIB HOST rather than GPIB DEVICE. The Reference meter port should not be used to control the 4000 series over GPIB bus.*

### 3.14 Updating Firmware via USB

The 4000 Series provides the facility to improve functionality via Firmware updates that can be applied by the end user via USB.

*Note :*

*Updating firmware is at the users risk. Although security checks are performed while applying updates, incorrectly applying firmware updates (corrupted memory stick, invalid updates, removing memory stick during the update process, power failures) run the risk of loss of data / functionality.*

To update firmware of the 4000 Series via USB, a blank memory stick formatted as FAT32 is required.

Transmille will provide an update package to be copied across to the memory stick using a computer. After copying the contents of the update package to the memory stick, the memory stick should be connected to the Front Panel USB Connector (see Figure 9 on Page 31).

After waiting approximately 5 seconds for the USB stick to be recognised (if using a Transmille memory stick the active LED will light), select 'UPDATE FIRMWARE VIA USB' from the Configuration Menu.

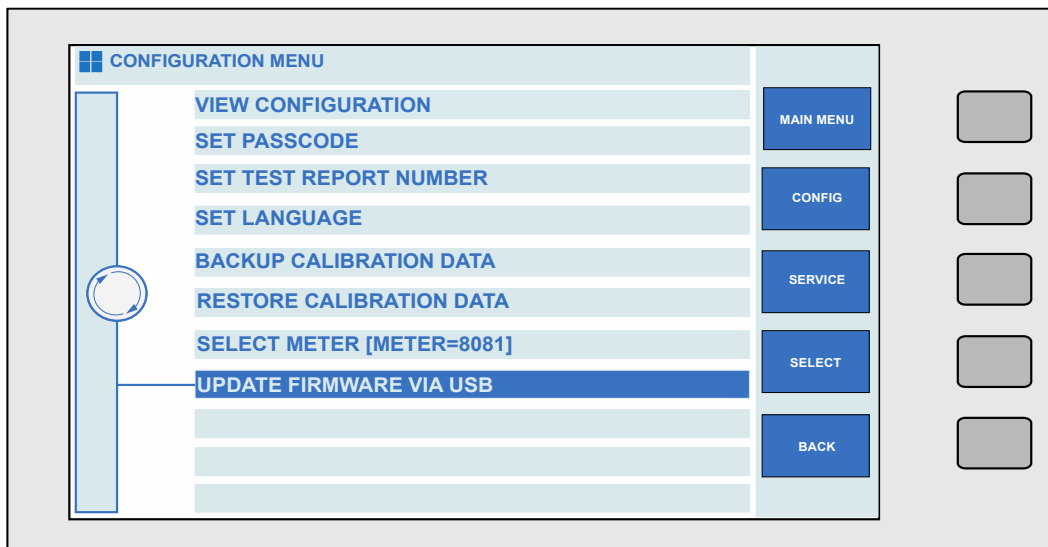

**Figure 25 – Update Firmware via USB Selected**

Pressing the 'SELECT' key, or pressing 'ENTER' will display a prompt showing progress of the firmware update.

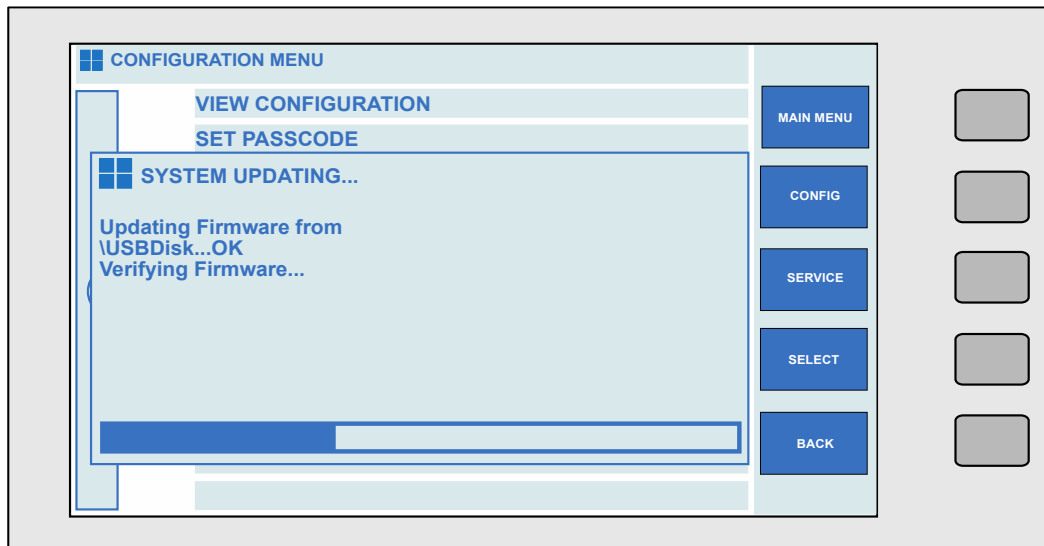

**Figure 26 - Firmware Update Progress Indication**

After the progress bar has filled, updated connection images, language databases and procedures will also be copied (if present) from the memory stick. If the update has been successful, a message will be displayed prompting removal of the USB stick and a message that the calibrator will restart.

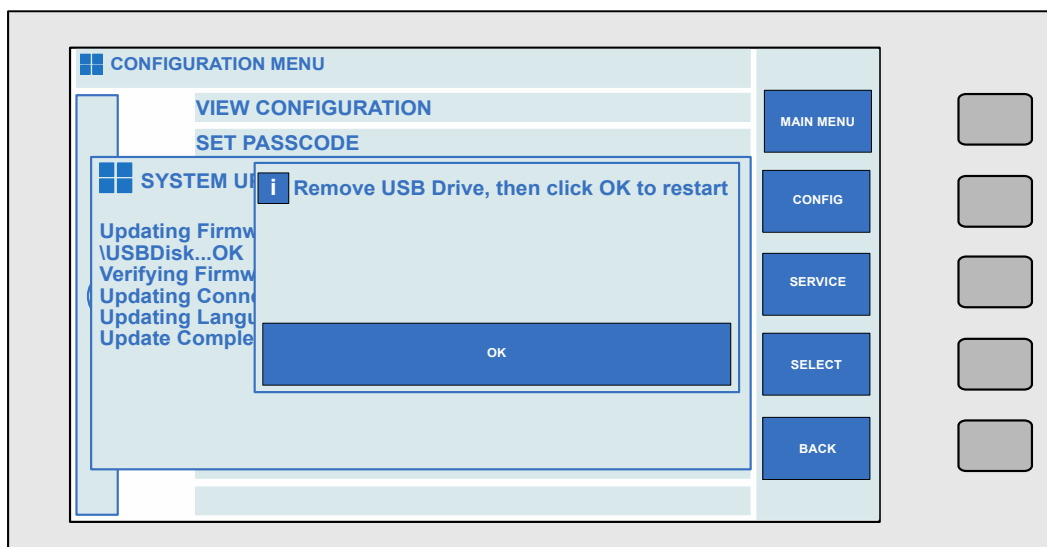

**Figure 27 – Firmware Update Successful**

After pressing 'OK', the calibrator screen will go blank while the calibrator restarts. The calibrator will restart to the 200mV DC range, with an output of 0mV set.

In the unlikely event of the firmware update being unsuccessful, unless the fault is due to a failure in the mains supply, an error message will be displayed on the screen indicating that the firmware update was unsuccessful.

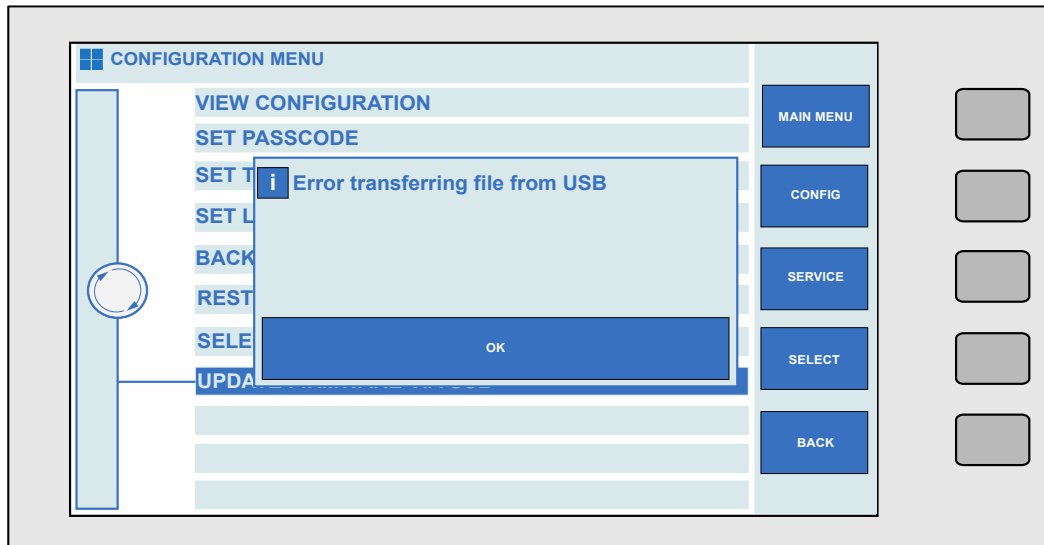

**Figure 28 – Firmware Update Error Message 1**

During a firmware update, system files are not overwritten until the update has been successfully validated, so no damage occurs to the system.

A second error message is then displayed to indicate that the update process has been exited.

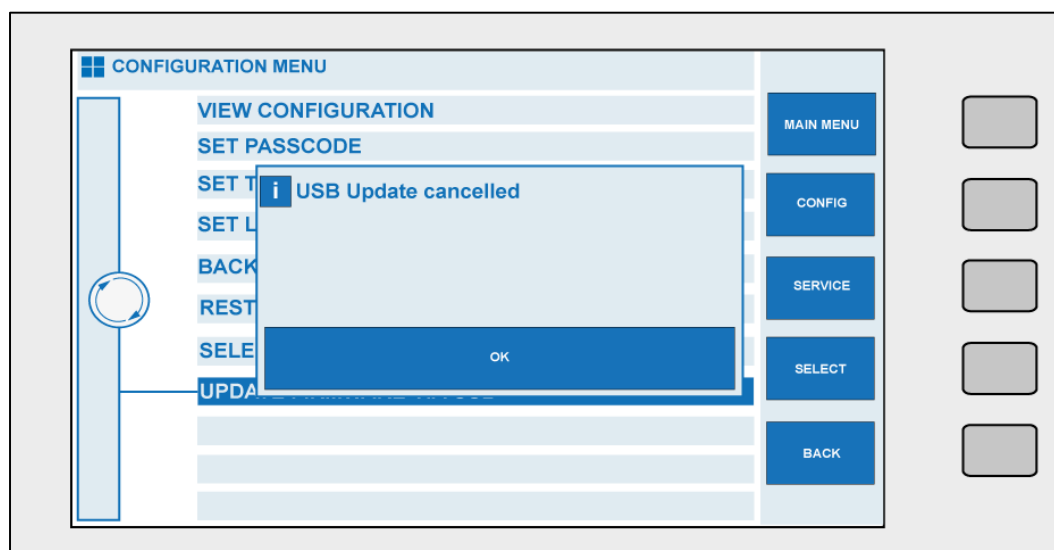

**Figure 29 – Firmware Update Error Message 2**

Causes for a failed update can include:  
TRANSMILLE LTD.

1. Faulty Memory Stick
2. Insufficient time being allowed for Memory Stick to initialise since insertion
3. Corrupt or Missing firmware update files.

In the case of a failed firmware update, Transmille or the local representative should be contacted before retrying to walk through diagnosis steps.

### 3.15 Special Functions Available Using the ‘Soft’ Keys

The ‘soft’ keys are positioned to the right hand side of the touchscreen display. The function of these keys will change depending on the parameter of the calibrator.

### 3.16 Connecting Output Negative to Line Earth (Ground)

The soft key and touch button ‘NEG TO GND’ switches the output negative terminal from floating to ground (line earth). The ‘on’ condition is shown at the top left of the display and also by the front panel LED.

We recommend that the default condition of output connected to ground is used as this reduces noise and pick up and decreases the risk of damage to the calibrator by incorrect connection.

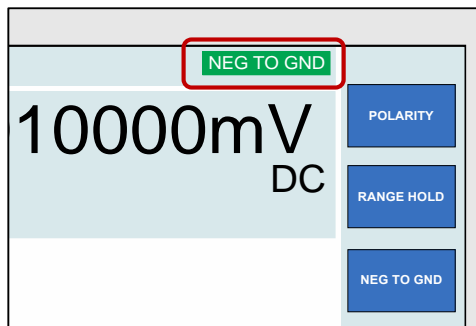
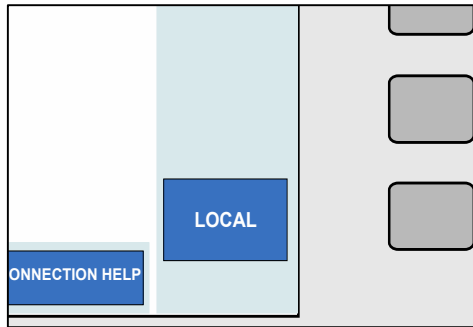

**Figure 30 - Negative to Line Earth Indication**

### 3.17 Selecting front panel control



When the calibrator has been controlled from the interface, the front panel controls are disabled. To regain front panel control, use the 'LOCAL' soft key



**Figure 31 – Local Key**

### 3.18 Terminal Status LED's

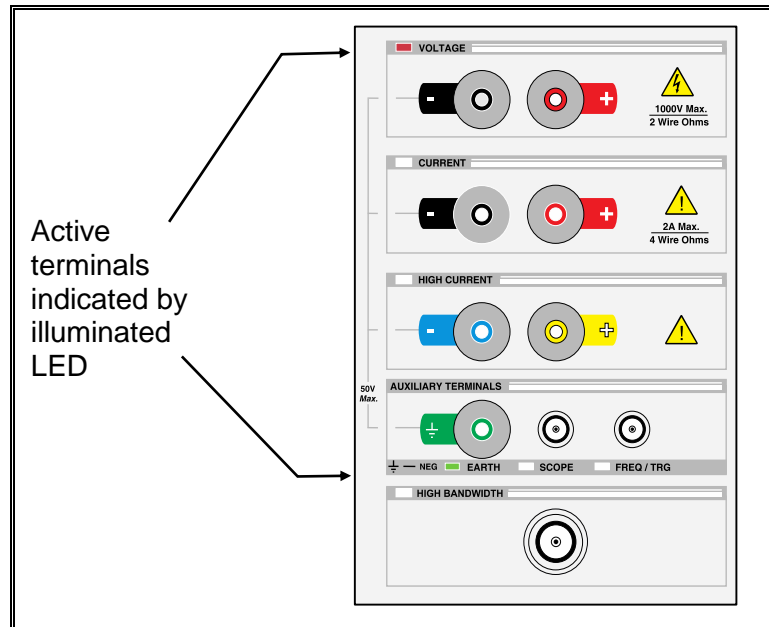

LED's above the terminals indicate which pair is active. When terminals are not active they are electrically isolated from each other, this enables terminals to be linked together if required.



**Figure 32 – Active Terminal LED's**

The terminals on the 4000 series and their status indication LED's can be seen in Figure 32. Each terminal is described in Table 2.

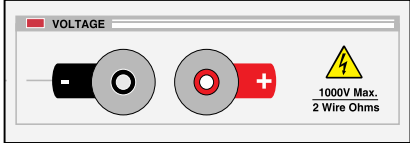
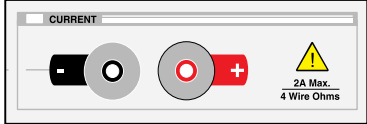
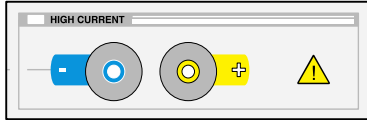
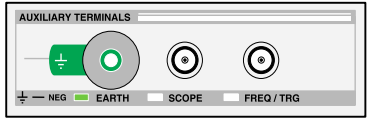
## Table 4 - Terminal Descriptions

<p><b>Voltage Output Terminal Pair (Black &amp; Red)</b></p> <p>Low thermal 4mm safety terminals used for all voltage outputs up to 1025V, for 2 wire/4 wire resistance, capacitance and inductance (optional).  <i>Note: the low 'black' terminal can be internally switched to line earth by a soft key function. When floating, the maximum voltage on this terminal with respect to ground should not exceed 50 Volts peak.</i></p>	
<p><b>Current Output Terminals (Black &amp; Red)</b></p> <p>4mm safety terminals for all current outputs up to 2 Amps, TTL frequency and for sense connection for 4 wire resistance.  <i>Note: the low 'black' terminal can be internally switched to line earth by a soft key function. When floating, the maximum voltage on this terminal with respect to ground should not exceed 50 Volts peak.</i></p>	
<p><b>30 Amps Output Terminals (Blue and Yellow)</b></p> <p>4mm Safety terminals used for all currents above 2 Amps.</p>	
<p><b>Earth Terminal (Green)</b></p> <p>Isolated BNC sockets for frequency and oscilloscope function outputs. They incorporate a green LED indicator to show when the terminal is active.</p> <p><b>Scope &amp; Frequency BNC Connector Outputs</b></p> <p>Isolated BNC sockets for frequency and oscilloscope function outputs. They incorporate a green LED indicator to show when the terminal is active.</p>	
<p><b>High Bandwidth Connector Output</b></p> <p>Type N connector for high bandwidth oscilloscope calibration module (internal option).</p>	

**WARNING:**

*Dangerous voltage or current may be present on these terminals.*

### 3.19 9 Pin Adapter Interface Connector

Used for connection to external pods used for extending calibration capability, e.g. Thermocouple simulation etc.

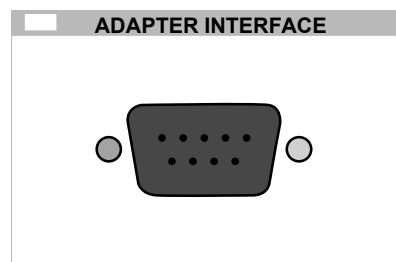

**Figure 33 - Adapter Interface 9 Way 'D' Type Connector (Female)**

This connector output incorporates a green LED to indicate when the adapter interface is active.

The pins connections are as follows:

Pin 1 – +15V

Pin 2 – Digital ground

Pin 3 – Strobe

Pin 4 – Data

Pin 5 – Select

Pin 6 – -15V

Pin 7 – Analogue ground

Pin 8 – Output

Pin 9 – Input

# 4 Connection Diagrams

Provided in this section are example connection diagrams for typical pieces of test equipment, indicating the terminals to use for each type of output.

## 4.1 AC/DC Voltage

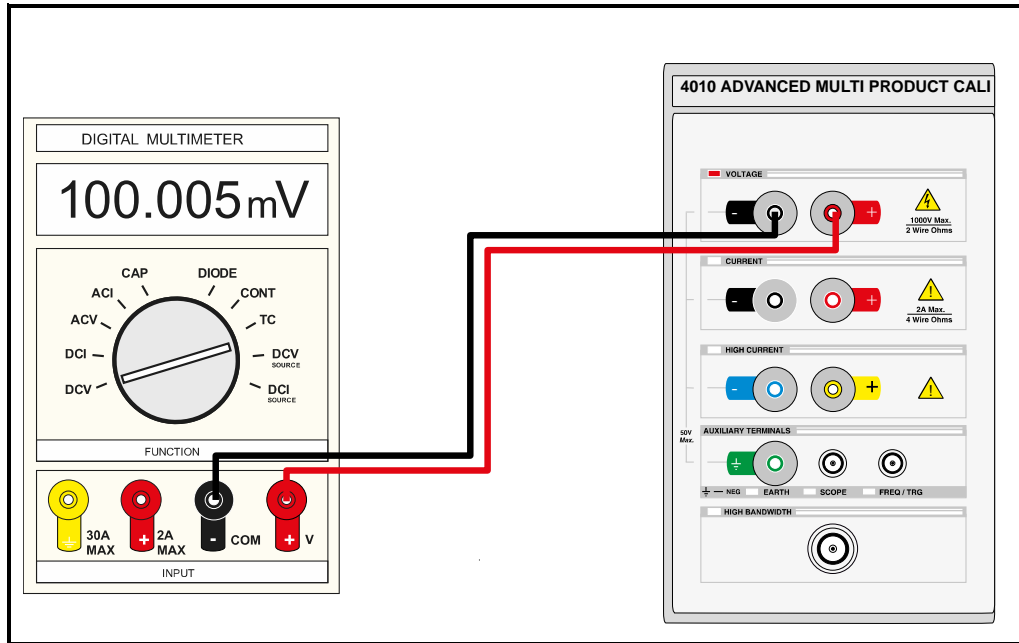
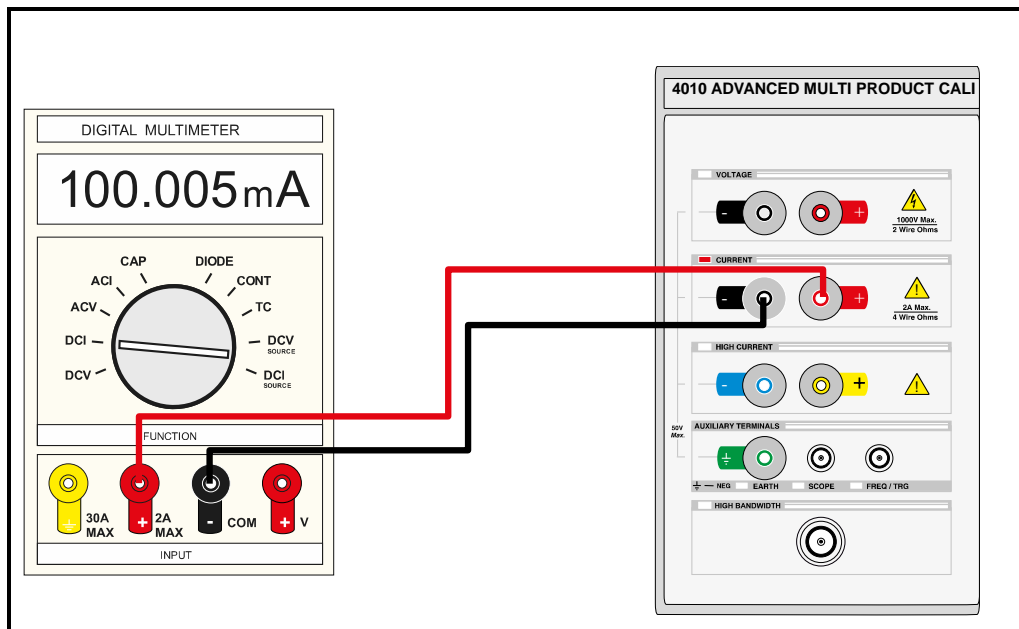

Figure 34 – AC / DC Voltage Connection

## 4.2 AC/DC Current Up to 2A



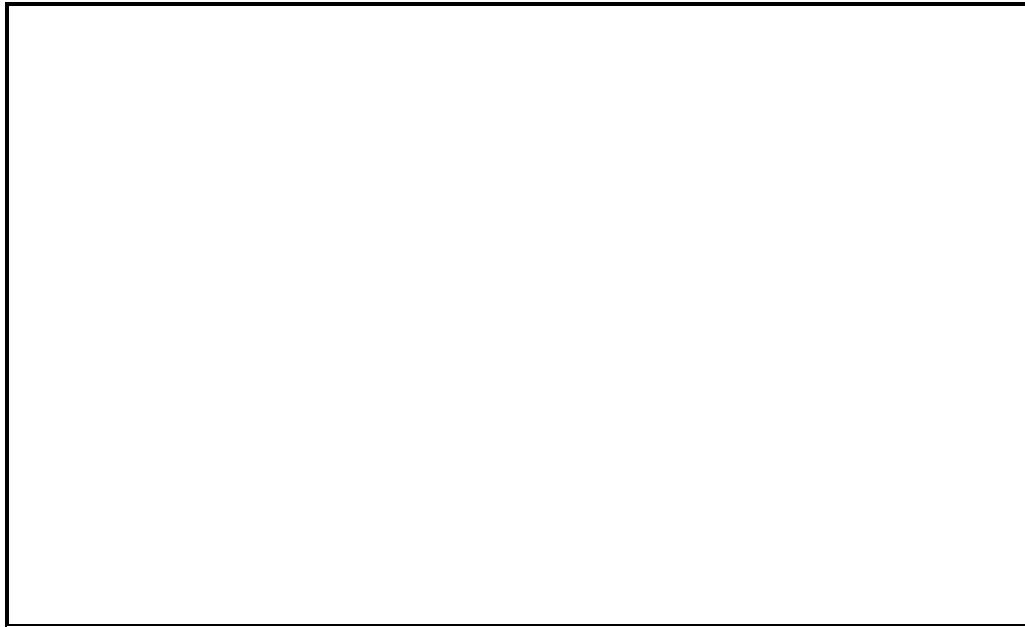

Figure 35 – AC / DC Current up to 2A

### 4.3 AC/DC Current above 2A

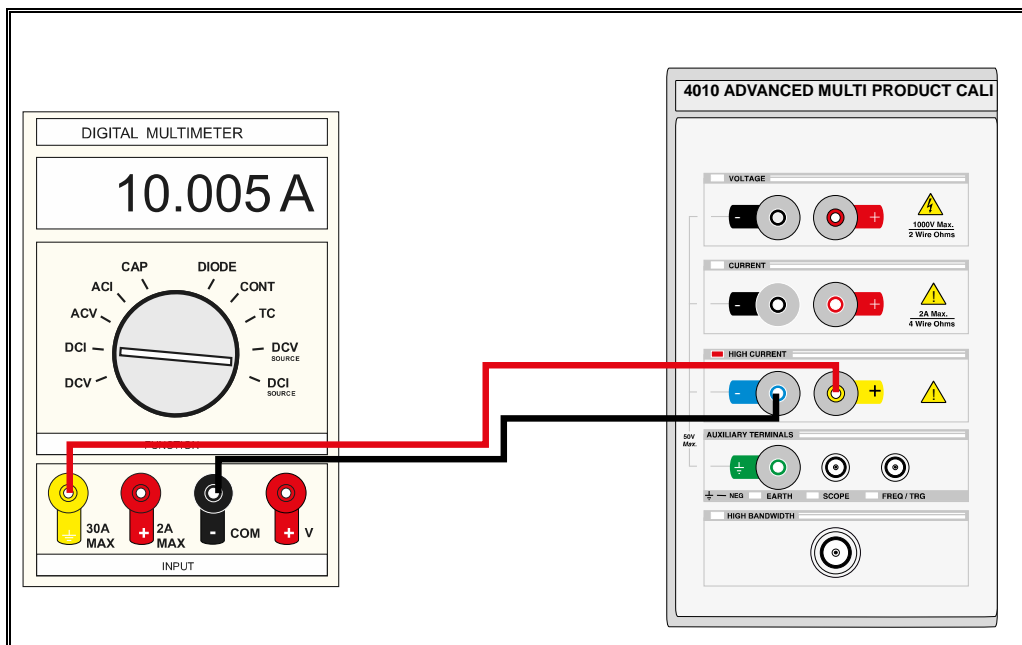

Figure 36 – AC / DC Current above 2A

## 4.4 2 Wire Resistance / Variable Resistance / Variable PRT

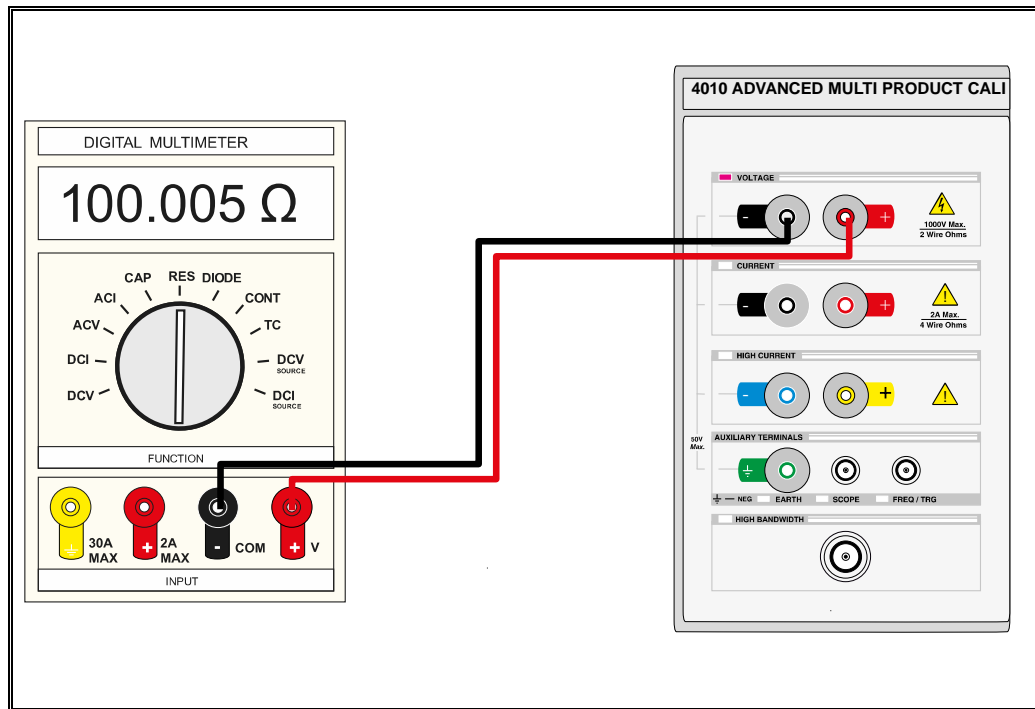

Figure 37 – 2 Wire Resistance / Variable Resistance / Variable PRT

## 4.5 4 Wire Resistance / Passive PRT

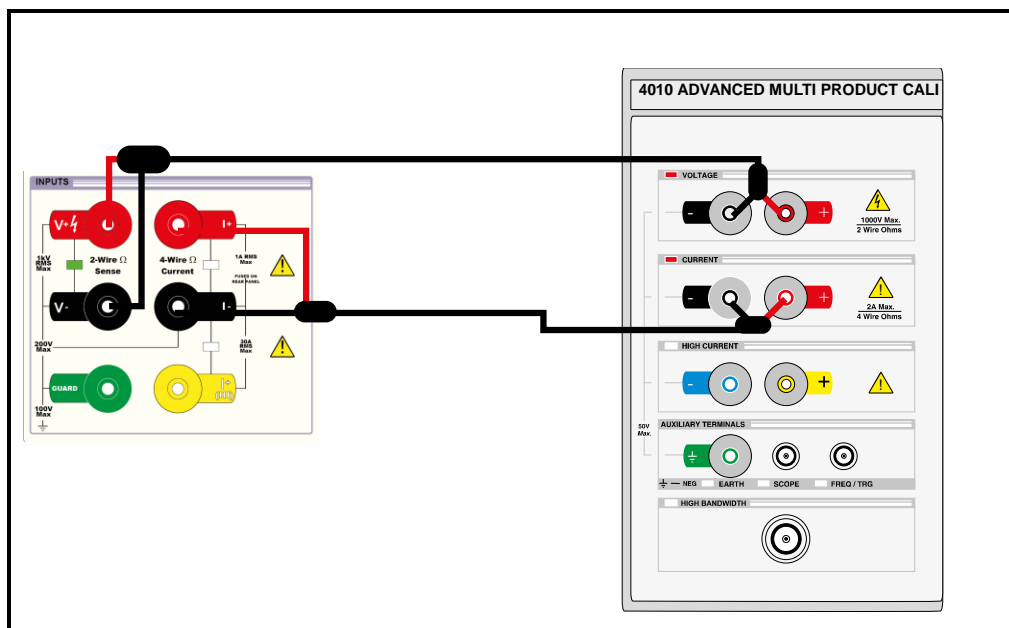

Figure 38 – 4 Wire Resistance / Passive PRT



## 4.6 Passive Capacitance / Variable Capacitance

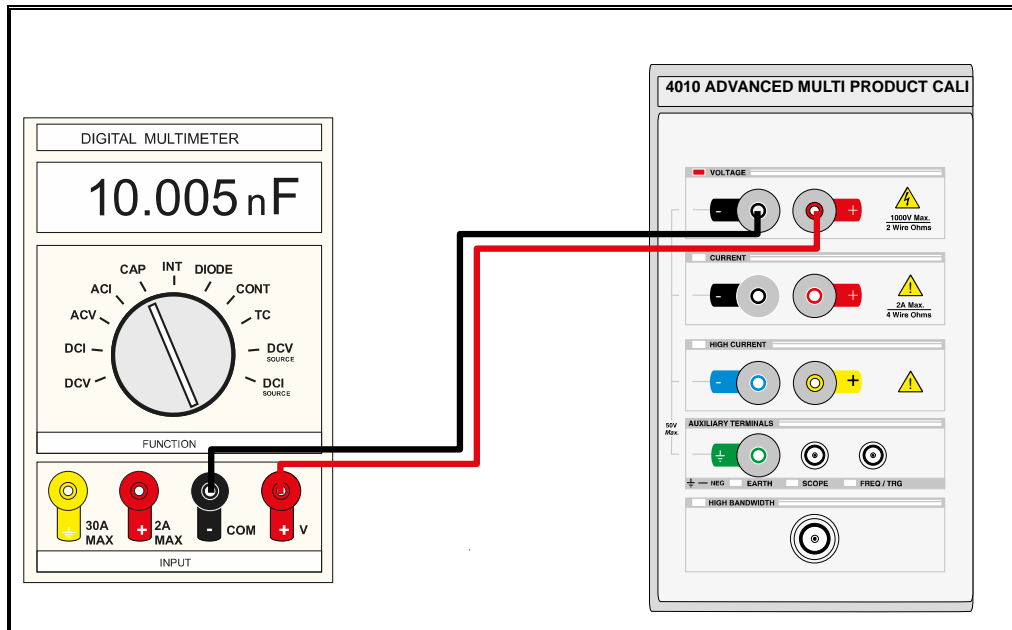

Figure 39 – Passive Capacitance / Variable Capacitance

## 4.7 Inductance (Optional)

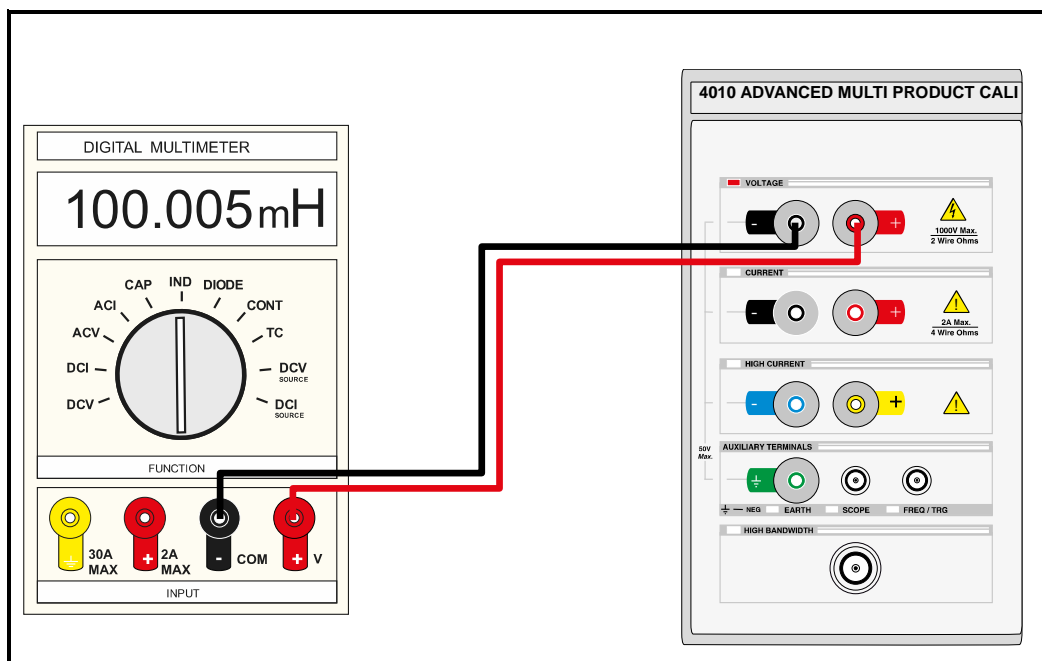

Figure 40 - Inductance

## 4.8 Frequency

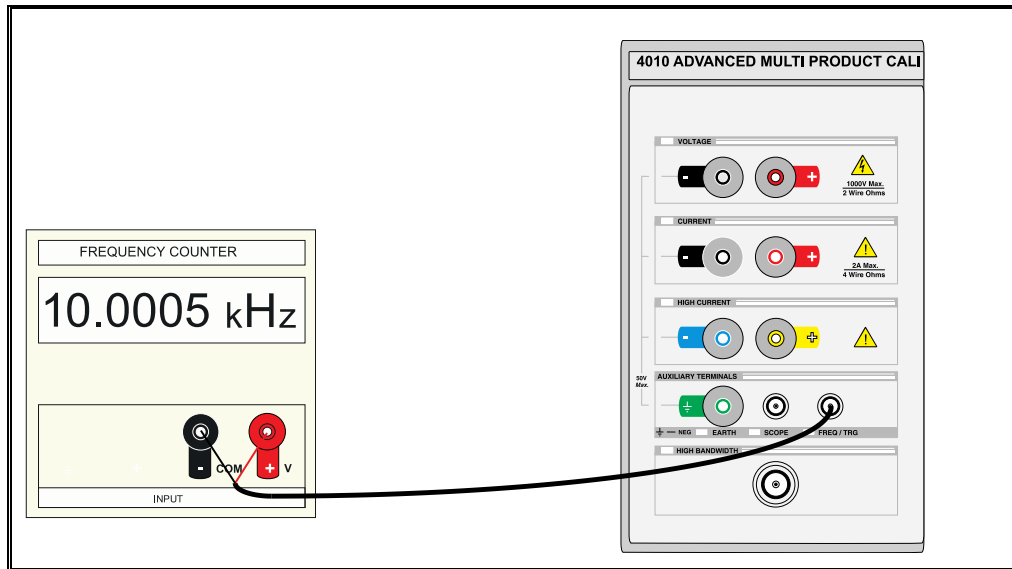

Figure 41 - Frequency

## 4.9 Pulse Width Modulation (PWM) / Duty Cycle

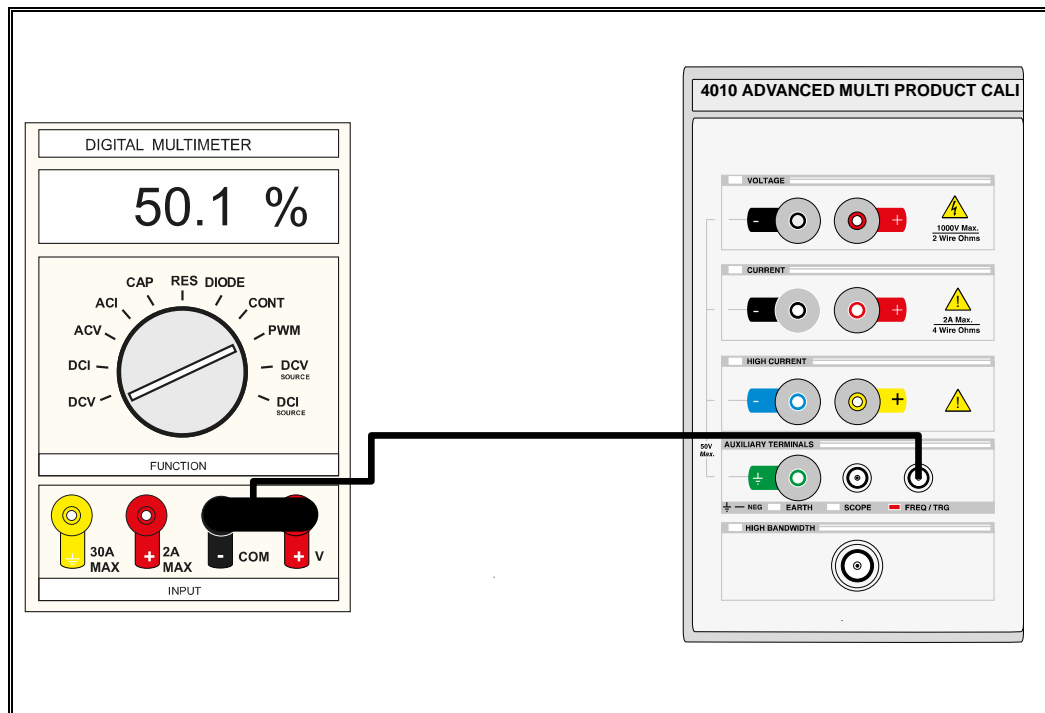

Figure 42 – Pulse Width Modulation (PWM) / Duty Cycle

## 4.10 Thermocouple Source using EA001A

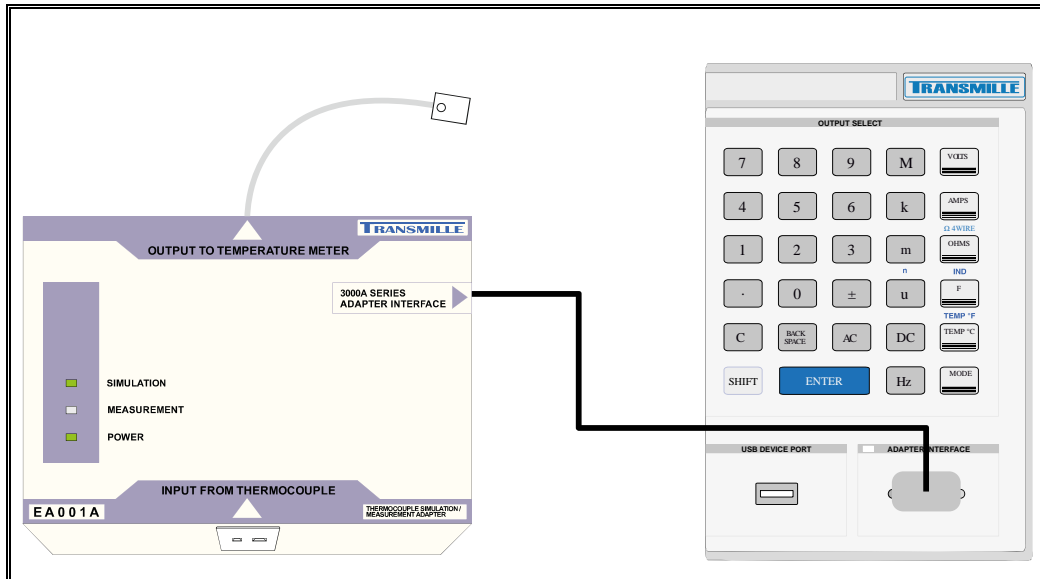

Figure 43 - Thermocouple Source Using EA001A

## 4.11 Current Simulation up to 1500A using EA002 coil adapter

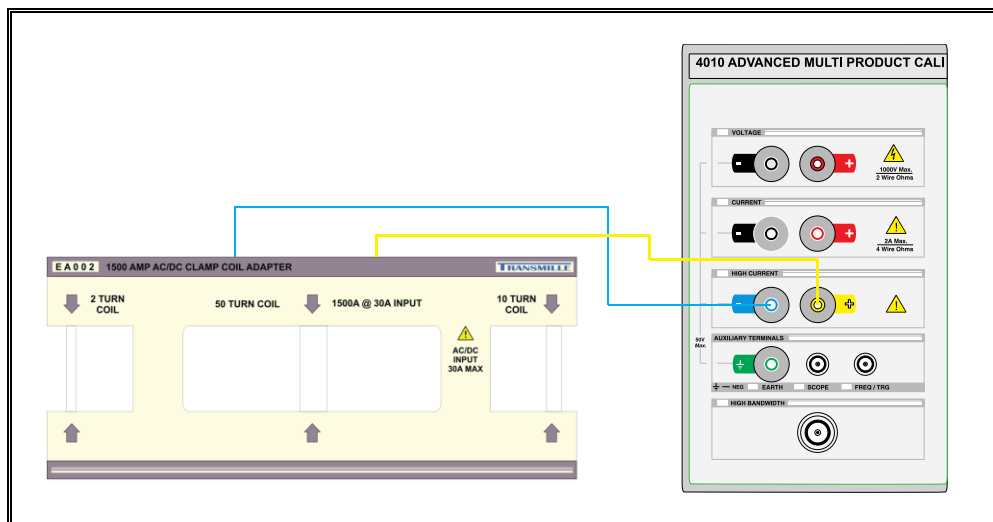

Figure 44 – Current simulation up to 1500A using Ea002 Coil Adapter

## 4.12 RPM Simulation using EA003

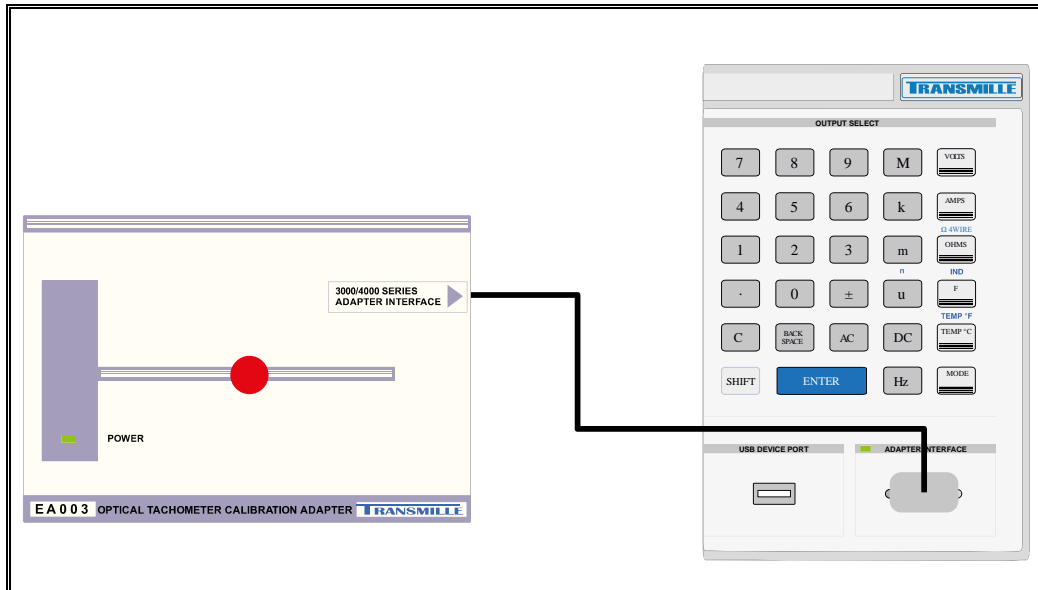

Figure 45 - RPM Simulation Using EA003

## 4.13 Oscilloscope Amplitude / Timebase / Rise Time

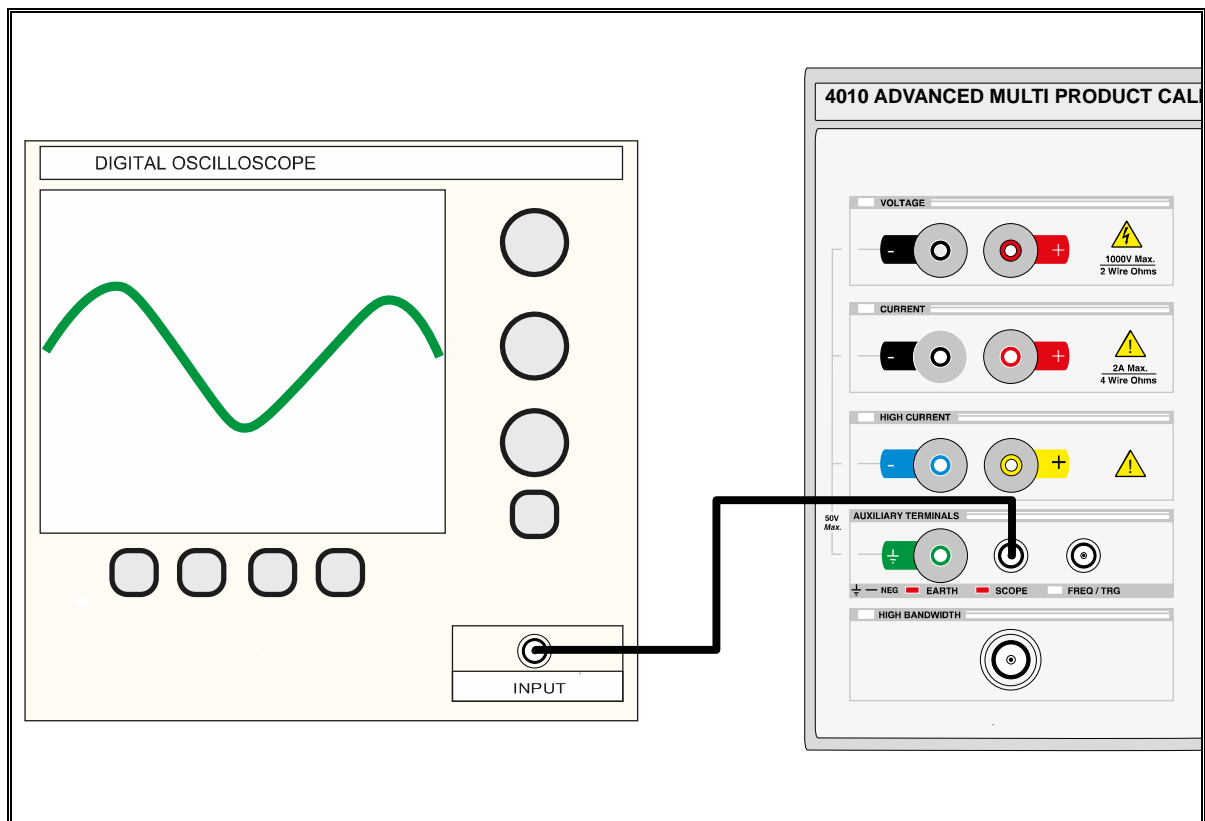

Figure 46 – Oscilloscope Amplitude / Timebase / Rise Time

## 4.14 Oscilloscope High Bandwidth

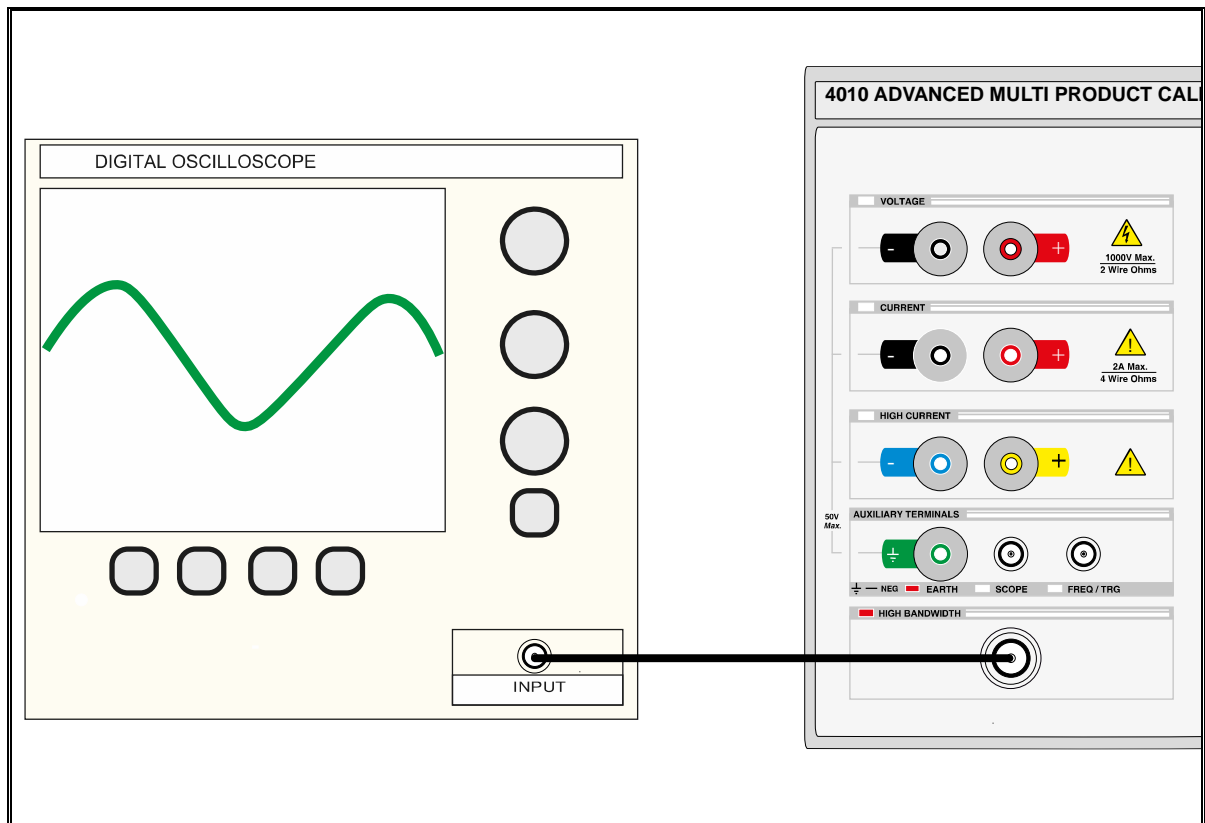

Figure 47 – Oscilloscope High Bandwidth

## 4.15 Power Calibration

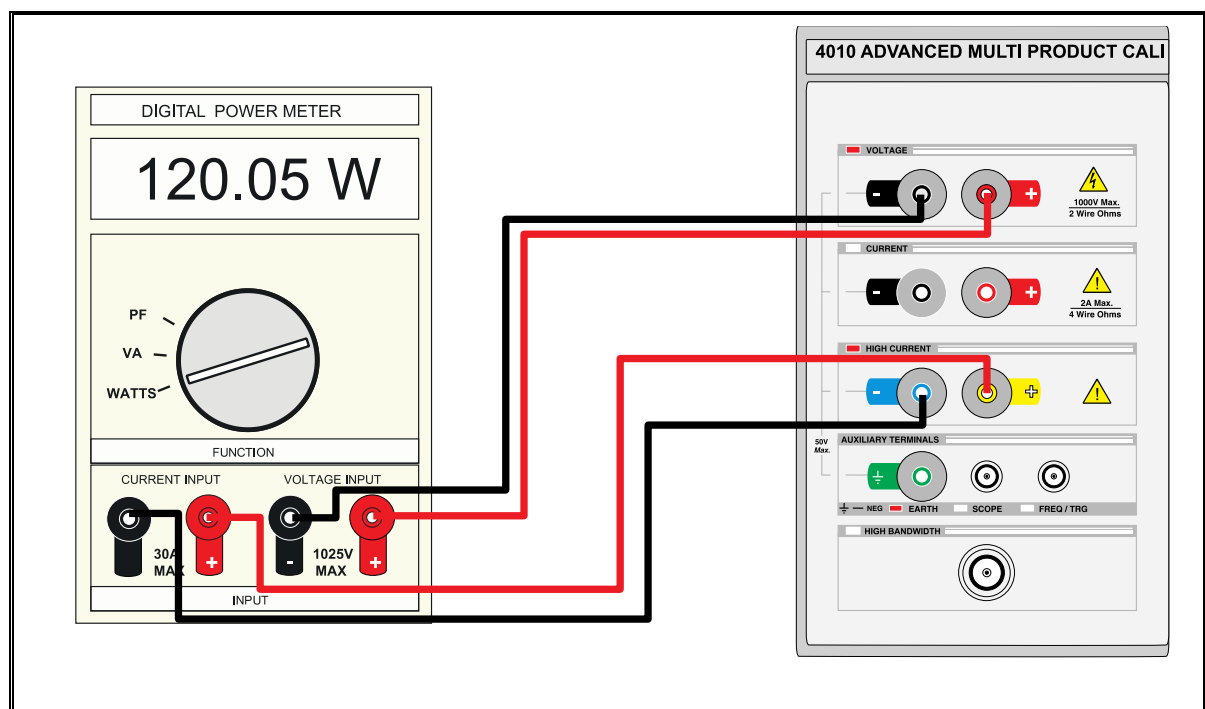

Figure 48 – Power Calibration

## 5 Setting Outputs

In this section configuring calibrator outputs will be described, with worked examples. To set the calibrator output, push the numerical keys required followed by a multiplier key, if required, and then a function key to identify which unit of measure is required (Volts, Amps, Ohms etc.). The front panel touchscreen shows the value and the units selected as you type them into the Calibrator. Once all numbers and units have been entered press the **ENTER** key. If an entry error is made, use the 'backspace' or 'C' (clear) soft keys to edit and delete the entry. Press **OUTPUT ON** to activate the calibrator output.

For example, input the following example sequence to set a DC voltage output:



Press **OUTPUT ON** to activate the calibrator output.

Input the following example sequence to set an AC voltage output:

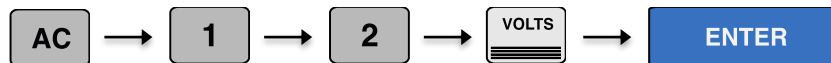

Then enter the required frequency value (e.g. 60 Hz):



Press **OUTPUT ON** to activate the calibrator output.

To change between DC and AC simply press either the **AC** or **DC** keys.

Once the required input has been entered, the digital potentiometer can be used to alter the value of the highlighted digit. The left and right cursor keys can be used to change which digit is highlighted. See 3.4 Digital Control for more information.

## 5.1 Adjusting the Set Output Using the Digital Control

After the output has been set, any digit of the output display can be incremented or decremented using either the digital control or the up and down arrow keys. The digit selected is indicated by the cursor and can be changed by using the left and right arrow keys. See section 3.4 Digital Control for more information.

## 5.2 Automatic Display of % or ppm Error and Reference Key

When the output value is changed by the methods above, the display will show the change in ppm or % from the original reference value entered from the keyboard. If needed, the reference value can be reset to the present value on the display by the REF key.

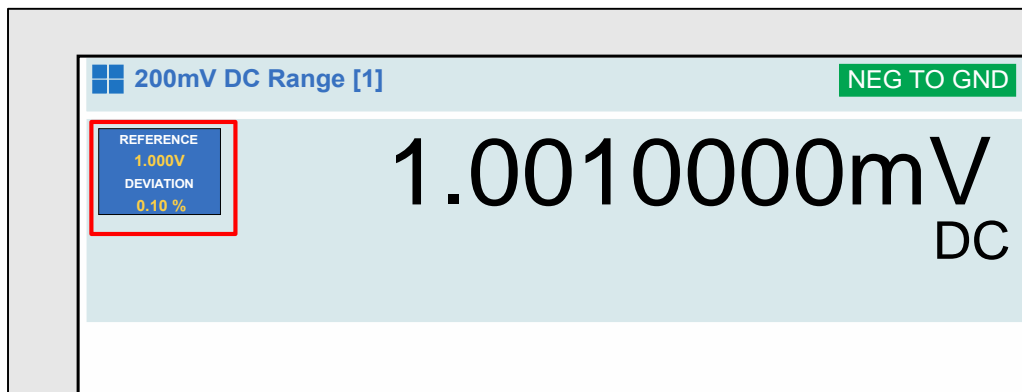

**Figure 49 – Position of % or PPM error from Reference Value**

This feature is ideal for displaying the error in a meter under test by adjusting the output from the calibrator to make the meter read the nominal value.

## 5.3 Range Hold

A soft key and direct touch button is available to toggle between manual and locked ranges. This function is primarily made to prevent small perturbation in the output through range changes, typically encountered when making linearity measurements.

The function is only available for single output DC and AC Voltage and Current. When 'Range Hold' is selected the selected range will not change when the output is edited. However, output values beyond that of the range cannot be entered. When 'Range Hold' is not selected the calibrator will automatically select the range that will give the best output resolution.

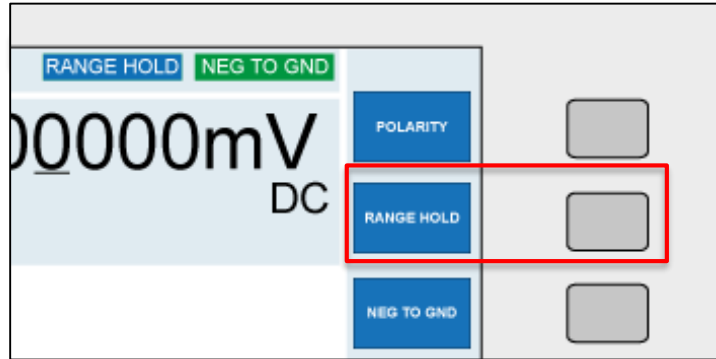

**Figure 50 – Range Hold Key**

## 5.4 Low Impedance Loads

All voltage ranges with exception of the 200mV AC/DC Voltage Ranges have sufficient compliance current available for almost all loads. When driving analogue meters with low voltage ranges that would use the 200mV AC/DC range, the 200mV range may not have sufficient compliance current.

Using the Range Hold function allows lower voltages to be simulated using the 2V AC/DC Voltage range.

The accuracy levels of analogue meters are such that using the 2V ranges will not significantly affect TUR.

The reason for limited compliance current on the 200mV ranges is due to a precision voltage divider used for the 200mV range of the 4000 series calibrator. This results in significantly lower noise output on low voltage ranges than equivalent calibrators, at the expense of lower available compliance current.



For modern meters with high input impedances and higher resolutions, this significantly improved noise performance improves noise floor specifications and performance rather than using direct outputs.

## 5.5 Setting a DC Voltage Output

Complete the following procedure to set a DC voltage output. If an entry error is made, use the 'backspace' or 'C' (clear) soft keys to edit and delete the entry.

- 1) Connect the unit under test to the 4000 series calibrator as required (see section 4.1 AC/DC Voltage for connection information).
- 2) Ensure the instrument to be calibrated has been set to measure the correct output on the desired range.
- 3) On the 4000 series, input the following example sequence to set a DC voltage output:



- 4) Press  to activate the calibrator output.

The calibrator will now produce 12 mV DC at the appropriate terminals.

Once on a range, any new output within that range can be set without the calibrator returning to standby. When a high voltage or high current values are entered the calibrator will automatically go into standby mode. To output this voltage or current, press the  key. This safety feature stops the accidental selection of high voltage or current.

## 5.6 Setting a DC Current Output

Complete the following procedure to set a DC current output. If an entry error is made, use the 'backspace' or 'C' (clear) soft keys to edit and delete the entry.

- 1) Connect the unit under test to the 4000 series calibrator as required (see section 4.2 and 4.3 for connection information).
- 2) Ensure the instrument to be calibrated has been set to measure the correct output on the desired range.
- 3) On the 4000 series, input the following example sequence to set a DC current output:



- 4) Press  to activate the calibrator output.

The calibrator will now produce 12 mA DC at the appropriate terminals.

Once on a range, any new output within that range can be set without the calibrator returning to standby. When a high voltage or high current values are entered the calibrator will automatically go into standby mode. To output this voltage or current, press the  key. This safety feature stops the accidental selection of high voltage or current.

*Note:*

*Ensure the correct output terminals are used when setting an output above 2A. See Table 4 and 4.3 for more information.*

## 5.7 Setting a AC Voltage Output

Complete the following procedure to set an AC voltage output. If an entry error is made, use the 'backspace' or 'C' (clear) soft keys to edit and delete the entry.

- 1) Connect the unit under test to the 4000 series calibrator as required (see section 4.1 AC/DC Voltage for connection information).
- 2) Ensure the instrument to be calibrated has been set to measure the correct output on the desired range.
- 3) On the 4000 series, input the following example sequence to set an AC voltage output:

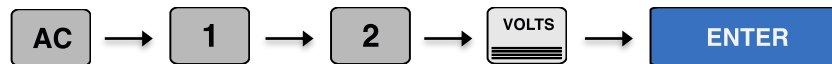

- 4) Then enter the required frequency value (e.g. 60 Hz):



- 5) Press  to activate the calibrator output.

The calibrator will now produce 12 V, 60 Hz AC at the appropriate terminals.

Once on a range, any new output within that range can be set without the calibrator returning to standby. When a high voltage or high current values are entered the calibrator will automatically go into standby mode. To output this voltage or current, press the  key. This safety feature stops the accidental selection of high voltage or current.

## 5.8 Setting a AC Current Output

Complete the following procedure to set an AC current output. If an entry error is made, use the 'backspace' or 'C' (clear) soft keys to edit and delete the entry.

- 1) Connect the unit under test to the 4000 series calibrator as required (see section 4.2 and 4.3 for connection information).
- 2) Ensure the instrument to be calibrated has been set to measure the correct output on the desired range.
- 3) On the 4000 series, input the following example sequence to set an AC current output:



- 4) Then enter the required frequency value (e.g. 60 Hz):



- 5) Press  to activate the calibrator output.

The calibrator will now produce 12 mA, 60 Hz AC at the appropriate terminals. Once on a range, any new output within that range can be set without the calibrator returning to standby. When a high voltage or high current values are entered the calibrator will automatically go into standby mode. To output this voltage or current, press the  key. This safety feature stops the accidental selection of high voltage or current.

*Note:*

*Ensure the correct output terminals are used when setting an output above 2A. See Table 4 and 4.3 for more information.*

## 5.9 Setting 2 Wire Passive Resistance Output.

Complete the following procedure to select 100kΩ in 2-wire mode. If an entry error is made, use the 'BACKSPACE' or 'C' (clear) soft keys to edit and delete the entry.

*Note:*

*The calibrator uses standard resistors of fixed decade values. The nearest available resistance to the entered value will be automatically selected.*

- 1) Connect the meter under test to the 4000 series calibrator as required (see section 4.4 2 Wire Resistance / Variable Resistance / Variable PRT for connection information).
- 2) Ensure the instrument to be calibrated has been set to measure the correct output on the desired range.
- 3) On the 4000 series, input the following example sequence to set a 2-wire resistance value:



- 4) Press  to activate the calibrator output.

2-Wire resistance ranges can be selected directly from the touchscreen as seen in Figure 51 or by using the 'Range up' and 'Range down' keys.

The resistance displayed will be the calibrated value held in the non-volatile calibration memory for that standard. Note the values are different for 2 and 4-wire ohms.

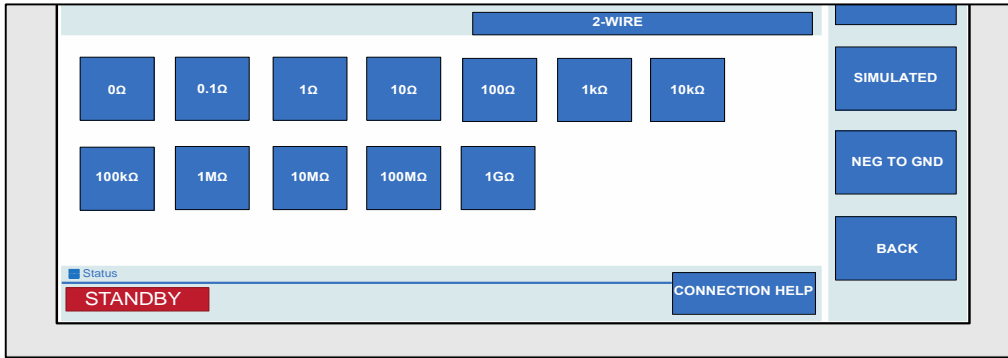

**Figure 51 – Direct resistance selection keys**

Alternatively, the 2-wire resistance mode can be selected using the functions menu, as illustrated below:

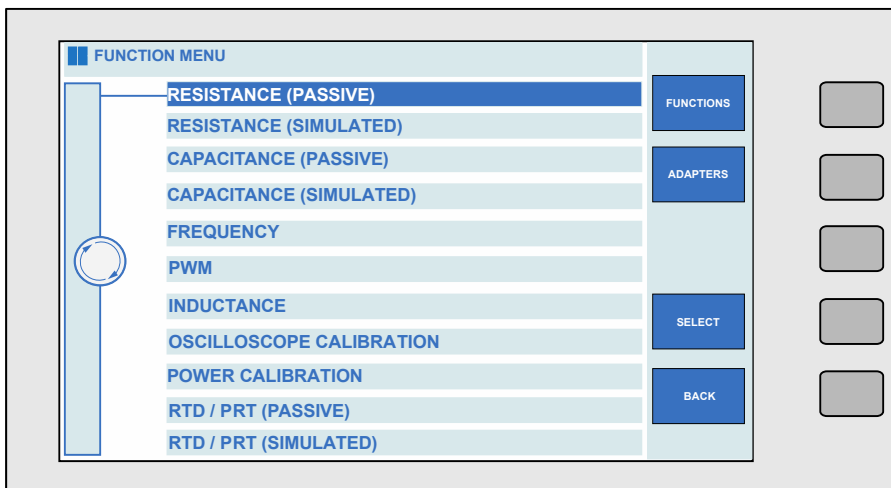

**Figure 52 - Resistance (Passive) Selection Using the Function Menu**

On the main DC voltage screen, using the soft keys or touchscreen, press the 'Functions' key. The following screen displays a list of available functions. Using the digital control or touchscreen directly, select the required function (in this case passive resistance). Once 'Resistance (Passive)' has been selected, 2-Wire mode is activated by default. The soft keys or direct touch buttons can be used to select 2-Wire mode, as seen in Figure 53.

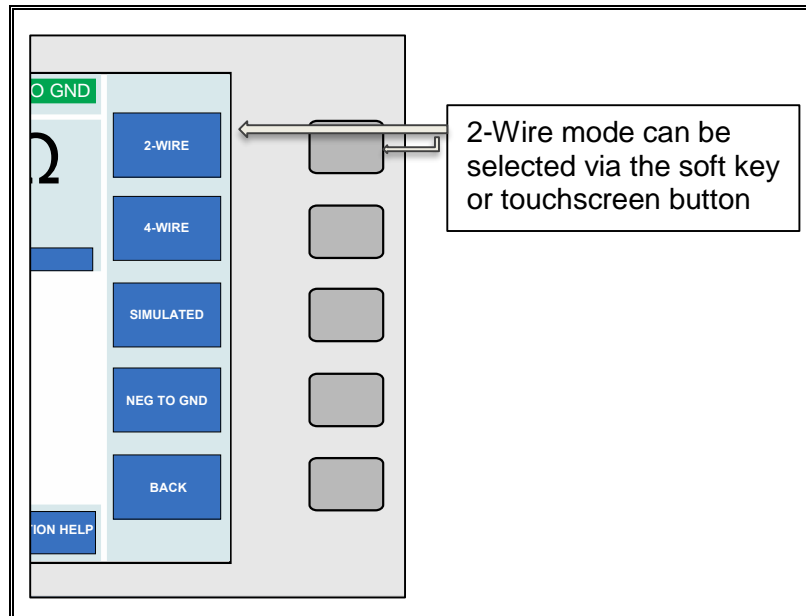

**Figure 53 - Soft Key and Direct Touch Selection of 2-Wire Mode**

## 5.10 Setting 2-Wire Simulated Resistance (Option)

The calibrator can simulate (Active) 2-wire resistance values in the range of  $0\Omega$  to  $10M\Omega$ .

Complete the following procedure to select  $100k\Omega$  in 2-wire simulated mode. If an entry error is made, use the 'backspace' or 'C' (clear) soft keys to edit and delete the entry.

1. From the resistance screen press the simulated soft key.

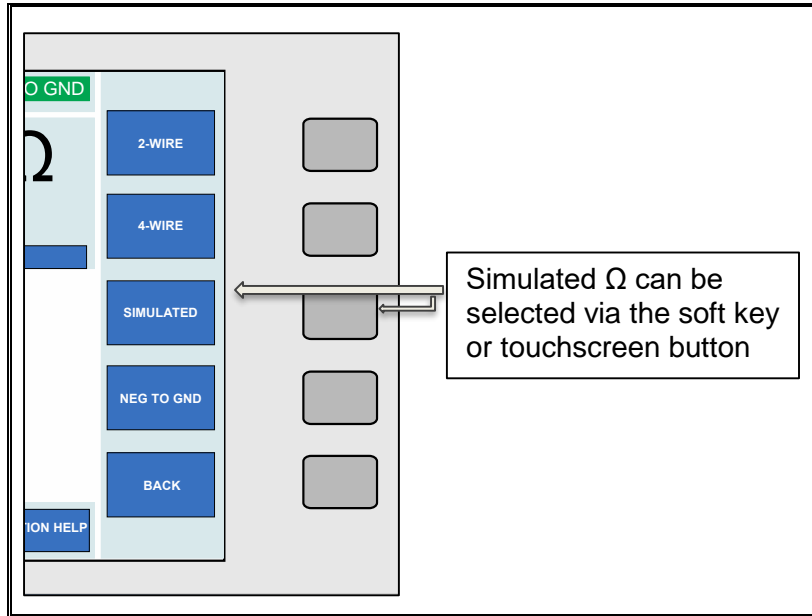

**Figure 54 – Soft Key and Direct Touch Selection of Simulated Resistance**

2. Connect the meter under test to the 4000 series calibrator as required (see section 2 Wire Resistance / Variable Resistance / Variable PRT on page 56 for connection information).
3. Ensure the instrument to be calibrated has been set to measure the correct output on the desired range.
4. On the 4000 series, input the following example sequence to set the resistance value:



5. Press  to activate the calibrator output.

Alternatively, the 2-wire simulated resistance mode can be selected using the functions menu, as illustrated below:



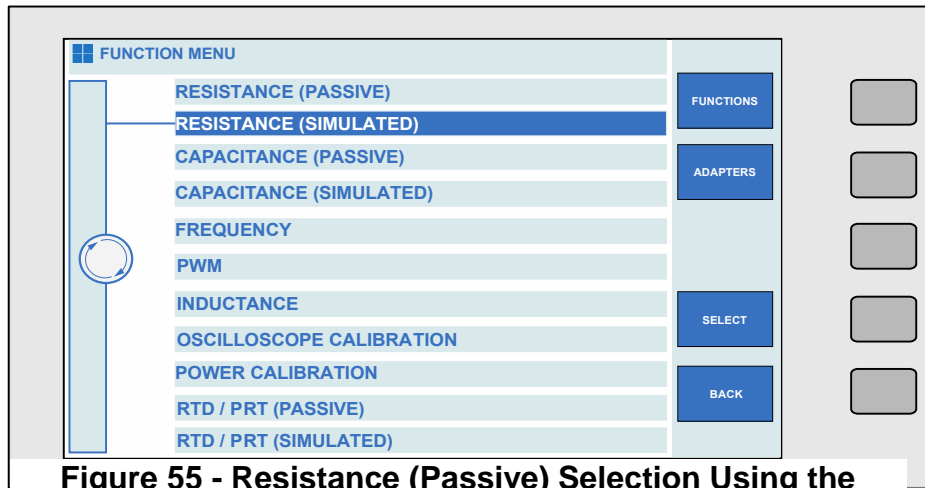

**Figure 55 - Resistance (Passive) Selection Using the Function Menu**

On the main DC voltage screen, using the soft keys or touchscreen, press the 'Functions' key. The following screen displays a list of available functions. Using the digital control or touchscreen directly, select the required function (in this case simulated resistance). 4-wire mode can then be selected from the soft key menu.

## 5.11 Setting 4-Wire Resistance Output

Complete the following procedure to select 100mΩ in 4-wire mode. If an entry error is made, use the 'backspace' or 'C' (clear) soft keys to edit and delete the entry.

*Note:*  
The calibrator uses standard resistors of fixed decade values. The nearest available resistance to the entered value will be automatically selected.

- 1) Connect the meter under test to the 4000 series calibrator as required (see section 4.5 4 Wire Resistance / Passive PRT for connection information).
- 2) Ensure the instrument to be calibrated has been set to measure the correct output on the desired range.
- 3) On the 4000 series, input the following example sequence to set a 4-wire resistance value:

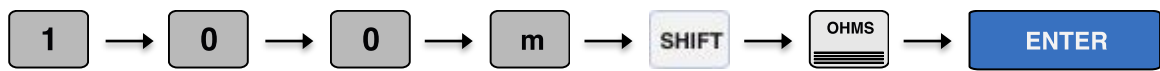

- 4) Press  to activate the calibrator output.

Other 4-wire ranges can be selected directly from the touchscreen when 4-wire mode is activated, as seen in Figure 56.

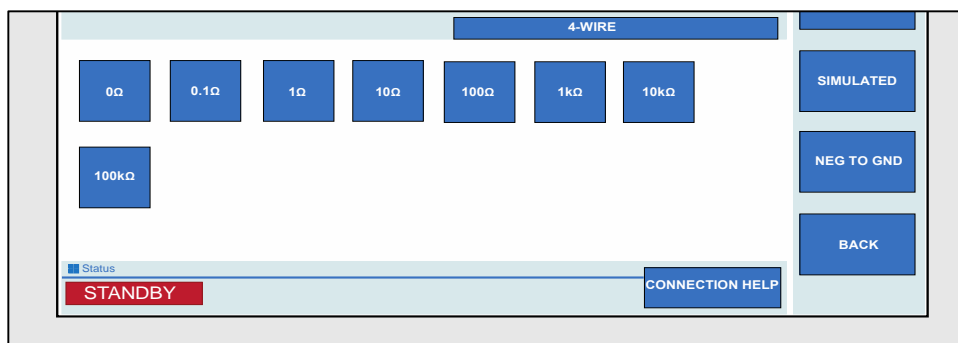

**Figure 56 - Direct Resistance Selection Keys**

The resistance displayed will be the calibrated value held in the non-volatile calibration memory for that standard. Note the values are different for 2 and 4 wire Ohms. 4-wire Ohms is indicated on the terminal LED's by both the voltage and current terminal LEDs illuminating.

Alternatively, the 4-wire resistance mode can be selected using the functions menu, as illustrated below:

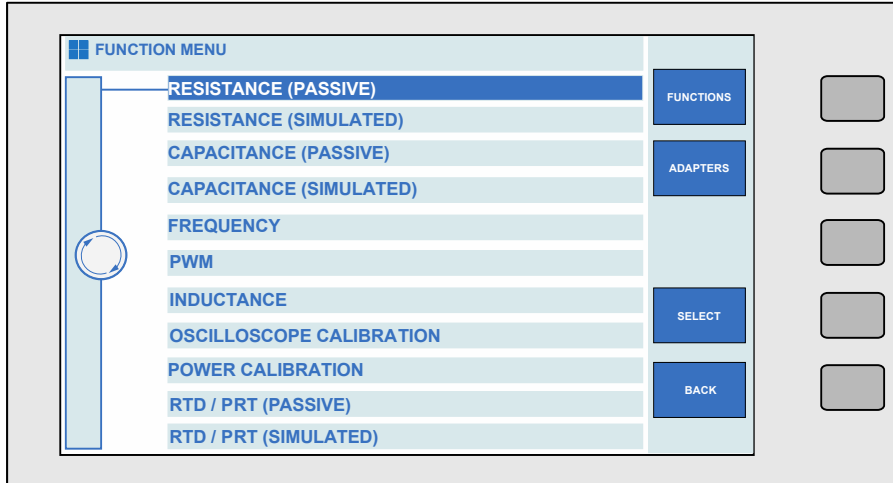

**Figure 57 – Resistance (Passive) Selection Using the function Menu**

On the main DC voltage screen, using the soft keys or touchscreen, press the 'Functions' key. The following screen displays a list of available functions. Using the digital control or touchscreen directly, select the required function (in this case passive resistance). Once 'Resistance (Passive)' has been selected, 2-Wire mode is activated by default. The soft keys or direct touch buttons can be used to select 4-Wire mode, as seen in

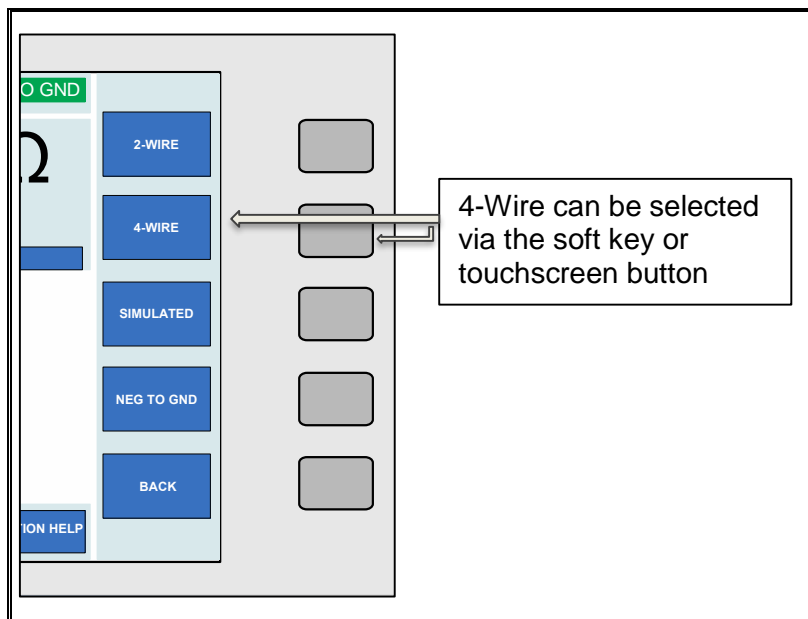

**Figure 58 - Soft Key and Direct Touch Selection of 4-Wire Mode**

## 5.12 Using Current Coils (Option)

The 4000 series calibrator can be used with the optional current coil EA002 (2, 10 and 50 turn coil) or any other current coil that does not exceed the burden voltage limits.

This enables currents both DC and AC of up to 1500A to be produced for the calibration of current clamp meters.

The current from the calibrator is connected the appropriate coil connections. The current output from the calibrator is then multiplied by the number of turns in that coil producing a higher current for the clamp to measure.

Complete the following procedure to select 500A DC using the 50 turn coil. If an entry error is made, use the 'backspace' or 'C' (clear) soft keys to edit and delete the entry.

- 1) First press the 'Functions' soft key or touch button to enter the functions menu.
- 2) Press the 'Adapters' soft key or touch button to enter the adapters menu.
- 3) Using the digital control, select 'EA002 clamp coil adapter' (touchscreen functionality can also be used here).
- 4) Select either 2, 10 or 50 turn coil type as required using the soft keys or touch button.
- 5) Input the following example sequence to set 500A DC 50 turn coil.

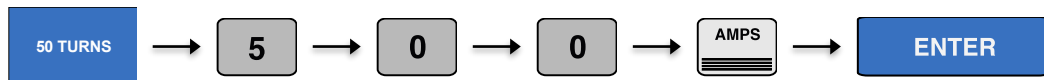

- 6) Press  to activate the calibrator output.

*Note:*

*30A range output is selected automatically as current output required >2A*

## 5.13 Setting Capacitance (Passive) Output

*Note:*

*The calibrator uses standard capacitors of fixed values. The nearest available capacitance to the entered value will be automatically selected.*

Complete the following procedure to select 100nF in Capacitance mode. If an entry error is made, use the 'backspace' or 'C' (clear) soft keys to edit and delete the entry.

- 1) Connect the meter under test to the 4000 series calibrator as required (see section 4.6 Passive Capacitance / Variable Capacitance for connection information).
- 2) Ensure the instrument to be calibrated has been set to measure the correct output on the desired range.
- 3) On the 4000 series, input the following example sequence to enter and set a Capacitance value:



- 4) Press  to activate the calibrator output.

Different Capacitance ranges can be selected directly from the touchscreen when Capacitance mode is activated, as shown in Figure 59.

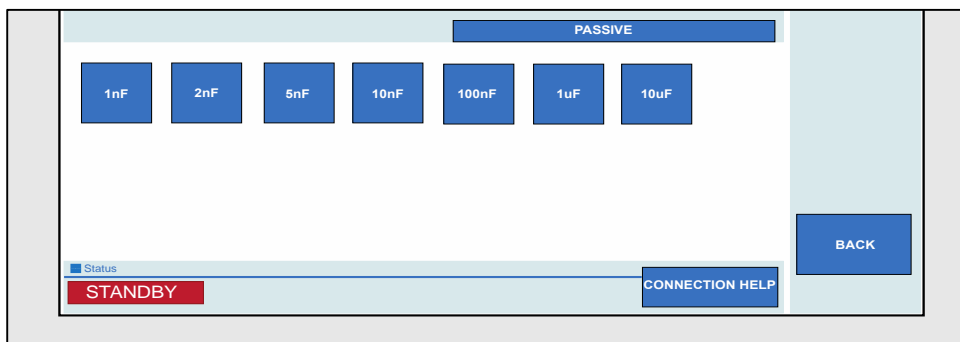

**Figure 59 – Direct Capacitance Selection Keys**

Capacitance is available at the voltage terminals as indicated by the LED. The capacitance displayed will be the calibrated value held in the non-volatile calibration memory for that standard. Note this is the value measured with a 1 kHz sine wave on a LCR bridge. When measuring capacitance, Cp (parallel) should be selected for values up to and including 1uF and Cs (series) for values above.

Alternatively, the passive Capacitance mode can be selected using the functions menu, as illustrated below:

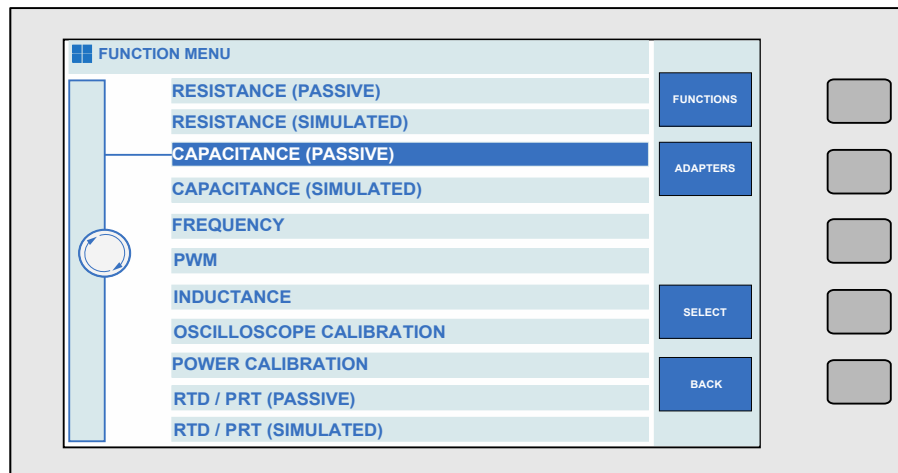

**Figure 60 - Capacitance (Passive) Selection Using Function Menu**

On the main DC voltage screen, using the soft keys or touchscreen, press the 'Functions' key. The following screen displays a list of available functions. Using the digital control or touchscreen directly, select the required function (in this case passive Capacitance).

## 5.14 Setting Capacitance (Simulated) Output

The calibrator can simulate a range of variable capacitance values (see extended specifications for available outputs).

Complete the following procedure to select and output in simulated capacitance mode. If an entry error is made, use the 'backspace' or 'C' (clear) soft keys to edit and delete the entry.

- 1) Connect the meter under test to the 4000 series calibrator as required (see section 4.6 Passive Capacitance / Variable Capacitance for connection information).
- 2) Ensure the instrument to be calibrated has been set to measure the correct output on the desired range.
- 3) Select 'Functions' using the soft key or touchscreen button.
- 4) Using the digital potentiometer, or by directly touching the required option, select 'Capacitance (Simulated)'.
- 5) Press the 'ENTER' or 'SELECT' key, the calibrator will enter the Simulated Capacitance Range
- 6) On the 4000 series, input the following example sequence to set a Capacitance output of 12uF

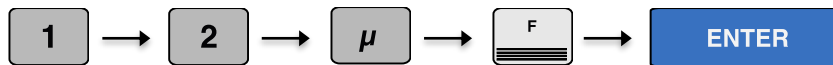

- 7) The calibrator will change automatically to the most appropriate range and the entered

- 8) Press  to activate the calibrator output.

Alternatively, the simulated capacitance mode can be selected using the functions menu, as illustrated below:

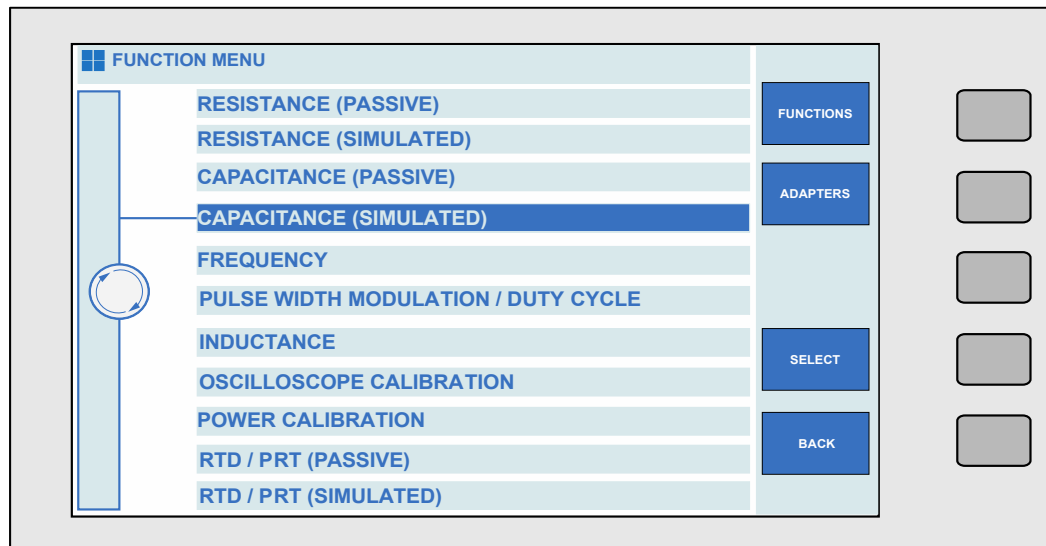

**Figure 61 – Capacitance (Simulated) Using Function Menu**

On the main DC voltage screen, using the soft keys or touchscreen, press the 'Functions' key. The following screen displays a list of available functions. Using the digital control or touchscreen directly, select the required function (in this case simulated capacitance).



## 5.15 Setting Inductance Output (Option)

*Note:*

*The calibrator uses standard inductors of fixed values. The nearest available inductance to the entered value will be automatically selected.*

Complete the following procedure to select 10mH in Inductance mode. If an entry error is made, use the 'backspace' or 'C' (clear) soft keys to edit and delete the entry.

- 1) Connect the meter under test to the 4000 series calibrator as required (see section 4.7 Inductance (Optional) for connection information).
- 2) Ensure the instrument to be calibrated has been set to measure the correct output on the desired range.
- 3) On the 4000 series, input the following example sequence to enter and set an Inductance value:



- 4) Press  to activate the calibrator output.

Inductance is available at the voltage terminals as indicated by the LED. The inductance displayed will be the calibrated value held in the non-volatile calibration memory for that standard.

Different Inductance ranges can be selected directly from the touchscreen when Inductance mode is activated.

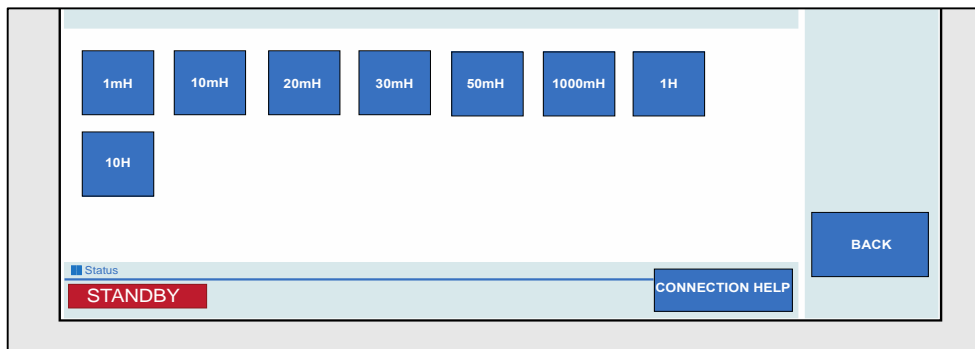

**Figure 62 – Direct Inductance Selection Keys**

Alternatively, Inductance can be selected using the functions menu, as illustrated below:

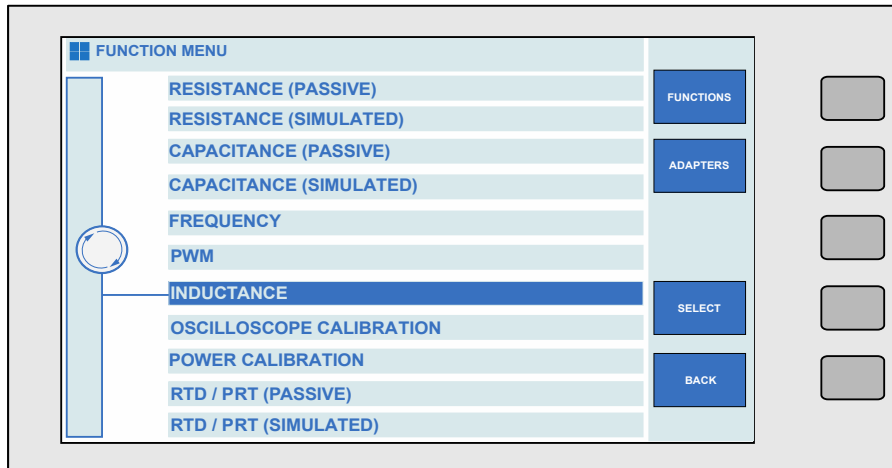

**Figure 63 – Inductance Selection Using Function Menu**

On the main DC voltage screen, using the soft keys or touchscreen, press the 'Functions' key. The following screen displays a list of available functions. Using the digital control or touchscreen directly, select the required function (in this case Inductance).

## 5.16 Thermocouple Simulation (Option)

The thermocouple simulation option allows the user to enter a temperature in °C and set the calibrator to the specific voltage output which corresponds to the thermocouple type selected.

On entering thermocouple simulation mode, type K will be the default function. The display (Figure 64) will indicate the current selected range and output status:

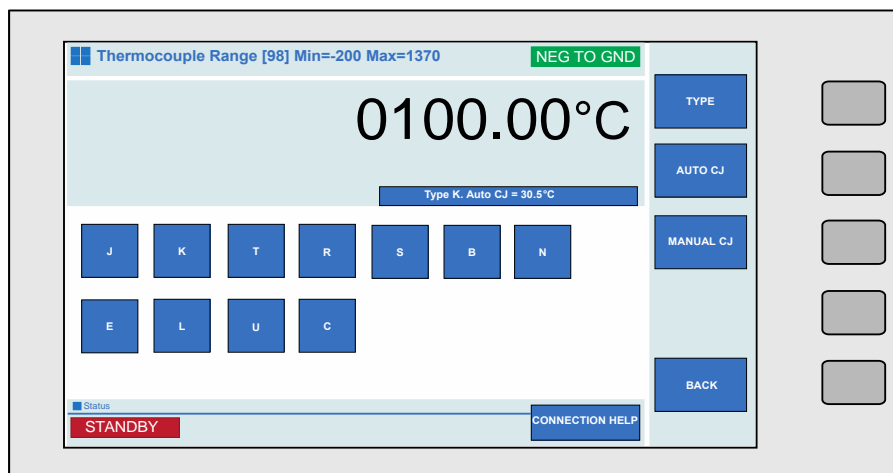



**Figure 64 – Thermocouple Simulation Menu**

The different Thermocouple types can be directly selected using the touchscreen.

Once in thermocouple mode, the menus available on the right hand of the screen reflect the thermocouple mode options - the available functions are:

**Table 5 - Thermocouple Functions**

	<p>Selects the manual cold junction (CJ) compensation mode.</p> <p>Press the key and input the required CJ temperature value via the numeric keypad on the touchscreen.</p>
	<p>Selects the automatic cold junction compensation mode. This allows the calibrator to use the built in temperature sensor within the adapter's thermocouple plug to compensate for the cold junction measured between the adapter plug and the UUT socket.</p>

Complete

the following procedure to select K type simulation equivalent to 450°C. If an entry error is made, use the 'backspace' or 'C' (clear) soft keys to edit and delete the entry.

- 1) First press the 'Functions' soft key or touch button to enter the functions menu.
- 2) Press the 'Adapters' soft key or touch button to enter the adapters menu.
- 3) Using the digital control, select 'EA001A Thermocouple adapter' (touchscreen functionality can also be used here).
- 4) Connect the thermocouple adapter to the adapter interface connection on the front panel of the 4000 series calibrator (See section 4.10 Thermocouple Source using EA001A for connection information).
- 5) Connect the unit under test to the thermocouple. Ensure the correct range has been selected.
- 6) Select the thermocouple type to be simulated as described above in this case K type.
- 7) Select the cold junction compensation options using the soft keys or touchscreen (see Table 5).

- 8) **For Manual CJ only:** Input the following example sequence, using the numerical keypad, to enter 0°C:

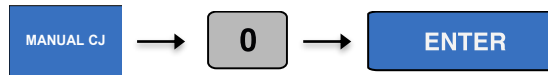

- 9) Press  to activate the calibrator output.

To change the temperature output from the nominal value, use the deviation function. This is controlled by using the left and right arrow keys to select the digit to be incremented. To increase or decrease the highlighted digit, use the up and down of the cursor keys or use the digital potentiometer (see section 3.4 Digital Control).

## 5.17 Setting Frequency Output

*Note:*

*The calibrator uses a precision Temperature Compensated Crystal Oscillator (TCXO). Frequencies from 1Hz to 1MHz in steps of 1 Hz are available together with the reference frequency of 10MHz.*

Complete the following procedure to select 10kHz in Frequency mode. If an entry error is made, use the 'backspace' or 'C' (clear) soft keys to edit and delete the entry.

- 1) Connect the meter under test to the 4000 series calibrator as required (see section 4.8 Frequency for connection information).
- 2) Ensure the instrument to be calibrated has been set to measure the correct output on the desired range.
- 3) On the 4000 series, input the following example sequence to enter and set the Frequency value:

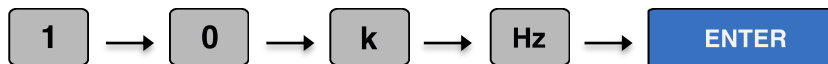

- 4) Press  to activate the calibrator output.

To change the Frequency output from the nominal value, use the deviation function. This is controlled by using the left and right arrow keys to select the digit to be incremented. To increase or decrease the highlighted digit, use the up and down of the cursor keys or use the digital potentiometer (see section 3.4 Digital Control). Furthermore, pressing the 'decades' button on the touchscreen allows decade values to be directly selected. This is illustrated in Figure 65.

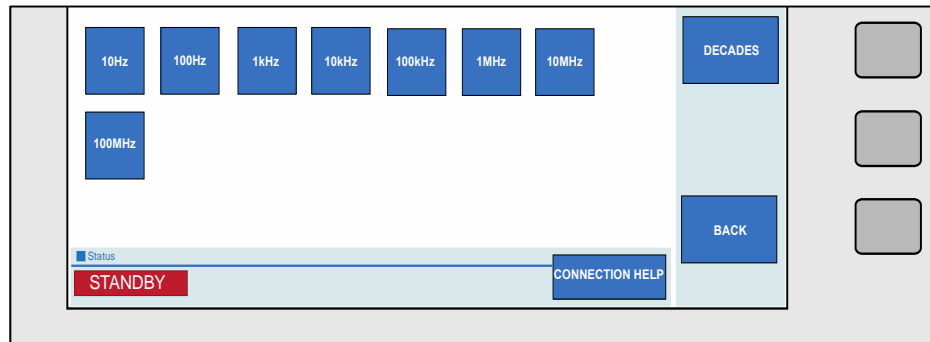

Figure

### Direct Frequency Selection Keys

Alternatively, Frequency can be selected using the functions menu, as illustrated below:

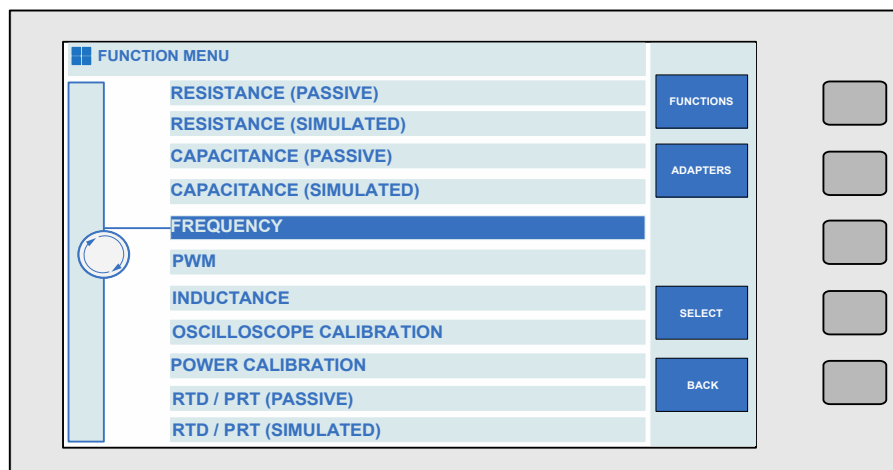

Figure 66 – Frequency Selection Using Function Menu

On the main DC voltage screen, using the soft keys or touchscreen, press the 'Functions' key. The following screen displays a list of available functions. Using the digital control or touchscreen directly, select the required function (in this case Frequency).

## 5.18 Setting RPM Output with EA003 Adaptor (Option)

*Note:*

*The calibrator uses a precision Temperature Compensated Crystal Oscillator (TCXO). Using the EA003 Optical Tachometer Calibration Adaptor the RPM can be set from 60 to 60000 RPM in 1 RPM steps.*

Complete the following procedure to select 1000RPM. If an entry error is made, use the 'backspace' or 'C' (clear) soft keys to edit and delete the entry.

- 1) First press the 'Functions' soft key or touch button to enter the functions menu.
- 2) Press the 'Adapters' soft key or touch button to enter the adapters menu.
- 3) Using the digital control, select 'EA003 Tachometer adapter' (touchscreen functionality can also be used here).
- 4) Connect the tachometer adapter to the adapter interface connection on the front panel of the 4000 series calibrator (See section 4.12 RPM Simulation using EA003 for connection information).
- 5) Connect the unit under test to the tachometer. Ensure the correct range has been selected.
- 6) Input the following example sequence, using the numerical keypad, to enter 1000RPM:

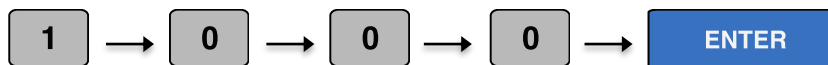

- 7) Press  to activate the calibrator output.

To change the output from the nominal value, use the deviation function. This is controlled by using the left and right arrow keys to select the digit to be incremented. To increase or decrease the highlighted digit, use the up and down of the cursor keys or use the digital potentiometer (see section 3.4 Digital Control).



Alternatively set RPM values can be directly selected using the soft keys or touchscreen buttons, as seen in Figure 67.

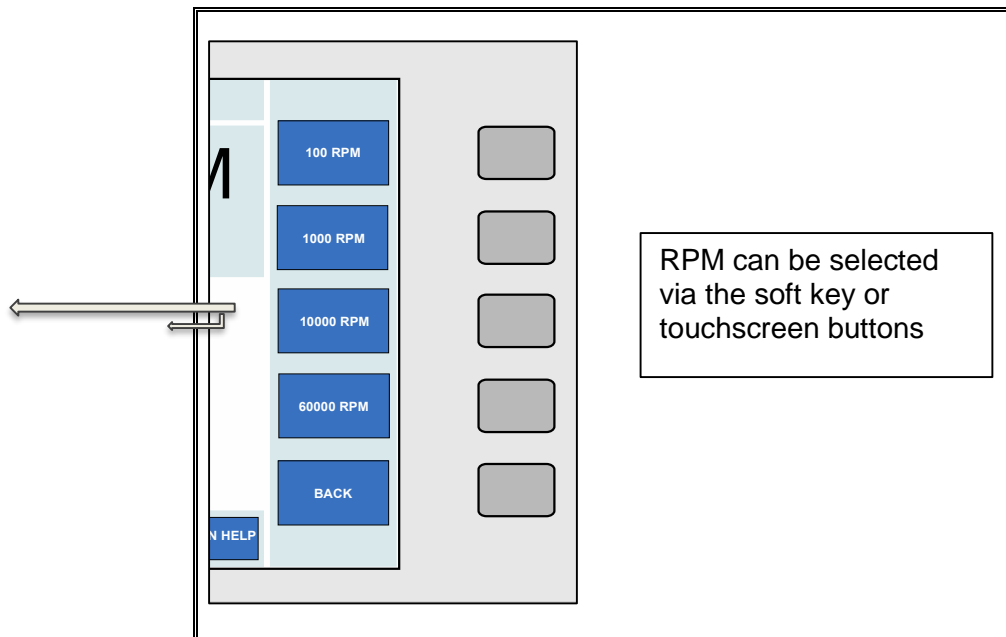

**Figure 67 – Soft Key and Direct Touch Selection of RPM Values**

## 5.19 Setting Pulse Width Modulation (PWM, Mark Space Ratio)

The calibrator can produce an accurate mark space ratio output within the frequency range 100Hz to 10kHz. The width of the pulse can be adjusted from 1% to 99% in 1% steps.

Complete the following procedure to set a PWM. If an entry error is made, use the 'backspace' or 'C' (clear) soft keys to edit and delete the entry.

1. Connect the meter under test to the 4000 series calibrator as required (see section 4.9 Pulse Width Modulation (PWM) / Duty Cycle for connection information).
2. Ensure the instrument to be calibrated has been set to measure the correct output on the desired range.
3. Select 'Functions' using the soft key or touchscreen button.
4. Using the digital potentiometer, or by directly touching the required option, select 'Pulse width modulation / duty cycle'.
5. On the 4000 series, input the following example sequence to enter and set the required Frequency value (e.g. 1kHz):



6. Press  to activate the calibrator output.

To change the required percentage from the nominal value, use the deviation function. This is controlled by using the left and right arrow keys to select the digit to be incremented. To increase or decrease the highlighted digit, use the up and down of the cursor keys or use the digital potentiometer (see section 3.4 Digital Control).

## 5.20 Selecting PRT (PT100) Resistance Output (Option)

The calibrator uses fixed value standard resistors. These resistors represent the following temperatures: -100°C, 0°C, 30°C, 60°C, 100°C, 200°C, 300°C and 800°C. The nearest available temperature to the entered value will be selected.

Complete the following procedure to select passive PRT. If an entry error is made, use the 'backspace' or 'C' (clear) soft keys to edit and delete the entry.

- 1) Connect the meter under test to the 4000 series calibrator as required (see section 4.5 4 Wire Resistance / Passive PRT for connection information).
- 2) Ensure the instrument to be calibrated has been set to measure the correct output on the desired range.
- 3) Select 'Functions' using the soft key or touchscreen button.
- 4) Using the digital potentiometer, or by directly touching the required option, select 'RTD / PRT (Passive)'.
- 5) On the 4000 series, input the following example sequence to enter and set the required temperature value (e.g. 100°C):



- 6) Press  to activate the calibrator output.

To change the required temperature, range from the nominal value, use the up and down of the cursor keys or use the digital potentiometer.

## 5.21 Selecting Simulated PRT Output (Option)

The calibrator can simulate PRT temperature values for RTD types 25 $\Omega$ , 100 $\Omega$ , 250 $\Omega$ , 500 $\Omega$  and 1000 $\Omega$  in the range -200 $^{\circ}$ C to 800 $^{\circ}$ C.

Complete the following procedure to select 100 $^{\circ}$ C in simulated PRT mode. If an entry error is made, use the 'backspace' or 'C' (clear) soft keys to edit and delete the entry.

- 1) From the passive PRT screen press the simulated soft key.

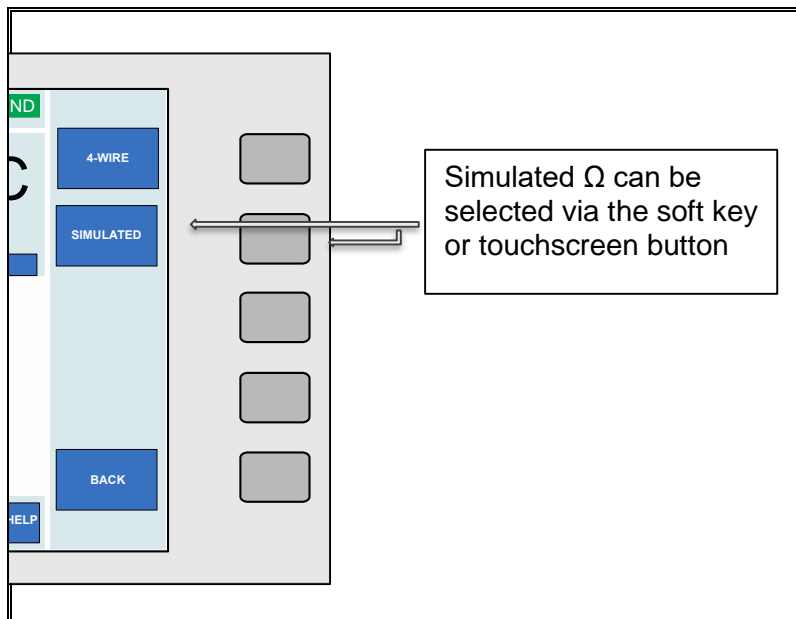

**Figure 68 – Soft Key and Direct Touch Selection of Simulated Ohms**

- 2) Connect the meter under test to the 4000 series calibrator as required (see section 4.42 Wire Resistance / Variable Resistance / Variable PRT for connection information).
- 3) Ensure the instrument to be calibrated has been set to measure the correct output on the desired range.
- 4) On the 4000 series, input the following example sequence to set the temperature value:



- 5) Press  to activate the calibrator output.

To change the required temperature from the nominal value, use the deviation function. This is controlled by using the left and right arrow keys to select the digit to be incremented. To increase or decrease the highlighted digit, use the up and down of the cursor keys or use the digital potentiometer (see section 3.4 Digital Control).

## 5.22 Selecting AC Power Calibration Output (Option)

The 4000 series calibrator can simulate power by simultaneously supplying AC voltage and AC current with a phase relationship.

Complete the procedure below to set a AC power output. If an entry error is made, use the 'backspace' or 'C' (clear) soft keys to edit and delete the entry.

- 1) Connect the meter under test to the 4000 series calibrator as required (see section 4.15 Power Calibration for connection information).
- 2) Ensure the instrument to be calibrated has been set to measure the correct output on the desired range.
- 3) Select 'Functions' using the soft key or touchscreen button.
- 4) Using the digital potentiometer, or by directly touching the required option, select 'Power Calibration'. The following screen will appear:

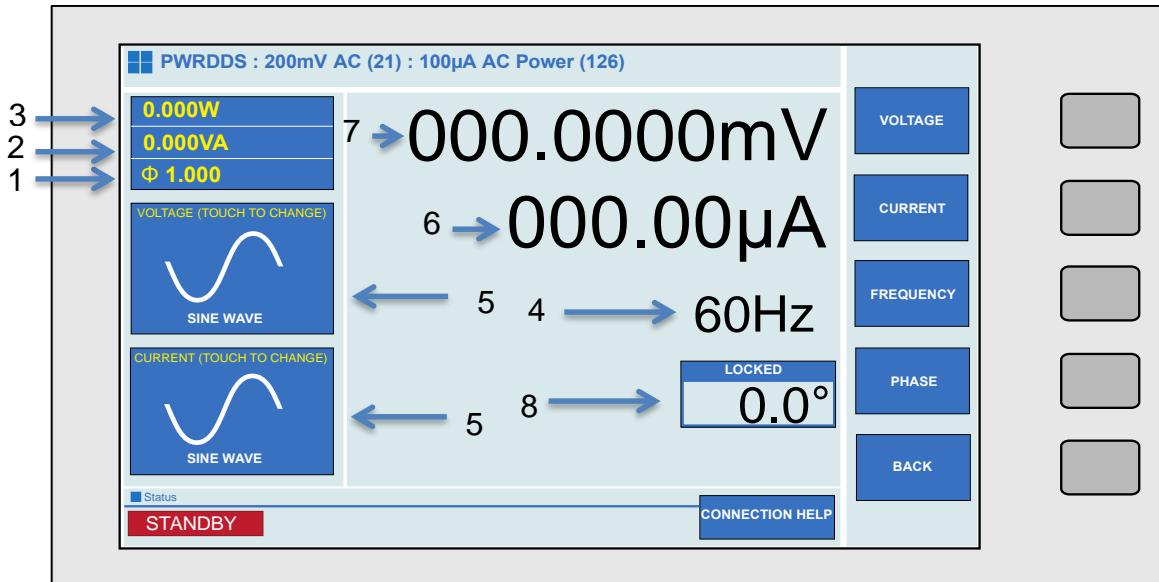

**Figure 69 - AC Power Menu Screen**

- |                         |                                    |
|-------------------------|------------------------------------|
| 1) Power Factor         | 5. Waveform Type (touch to change) |
| 2) Calculated VA Output | 6. Current Output                  |
| 3) Watts                | 7. Voltage Output                  |
| 4) Frequency            | 8. Phase Angle                     |

5) Using the numeric keypad, enter the required voltage value (e.g. 10 V).

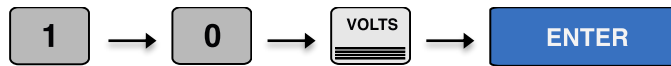

6) Then, using the numeric keypad, enter the required current value (e.g. 10 A).



7) Finally, using the numeric keypad, enter the required frequency value (e.g. 60 Hz).

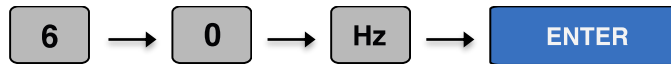

*Note:*

*Current output in power mode follows the same convention as normal current operation. Up to 2A is output from the low current terminals. 2.02 – 30A output from the high current terminals. See Section 4.3 on Page 55 for more information.*

Alternatively, to select and change the required output from the nominal value, the deviation function can be used. This is controlled by using the left and right arrow keys to select the digit to be incremented. To increase or decrease the highlighted digit, use the up and down of the cursor keys or use the digital potentiometer (see section Digital Control).

The required output can also be selected directly by using the soft keys or touchscreen buttons. This is illustrated in Figure 70.

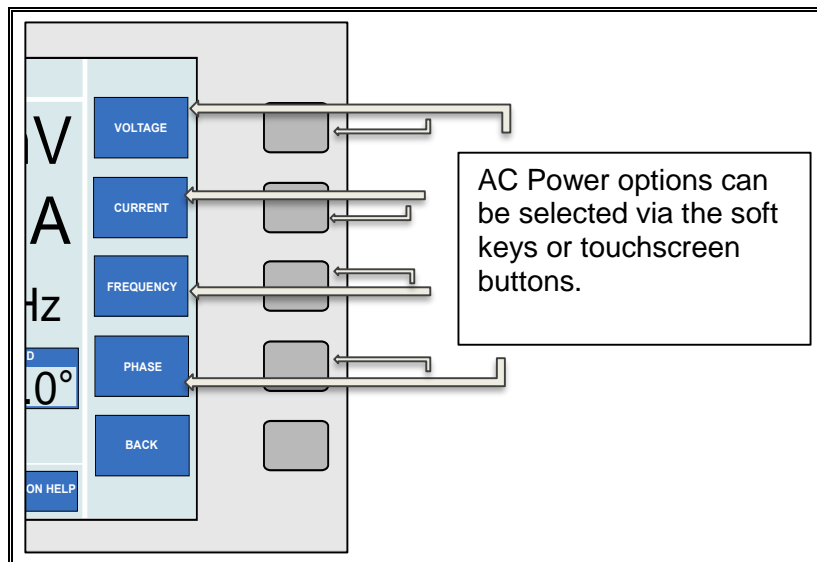

**Figure 70 – Soft Key and Direct Touch Selection of AC Power Options**

8) To change phase, select the phase soft key or touchscreen button and input the required value.

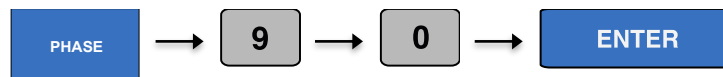

9) Press  to activate the calibrator output.

*Note:*

*When the 'locking' message is shown on the calibrator display, phase correction is in progress. Phase specifications do not apply until the icon is updated to display 'LOCKED'. See Figure 71.*



**Figure 71 – Phase Correction Indicator**



## 5.23 Selecting DC Power Calibration Output (Option)

The 4000 series calibrator can simulate DC power by simultaneously outputting DC voltage and DC current.

Complete the procedure below to set a DC power output. If an entry error is made, use the 'backspace' or 'C' (clear) soft keys to edit and delete the entry.

- 1) Connect the meter under test to the 4000 series calibrator as required (see section 4.15 Power Calibration for connection information).
- 2) Ensure the instrument to be calibrated has been set to measure the correct output on the desired range.
- 3) Select 'Functions' using the soft key or touchscreen button.
- 4) Using the digital potentiometer, or by directly touching the required option, select 'Power Calibration'. The following screen will appear (Figure 72).

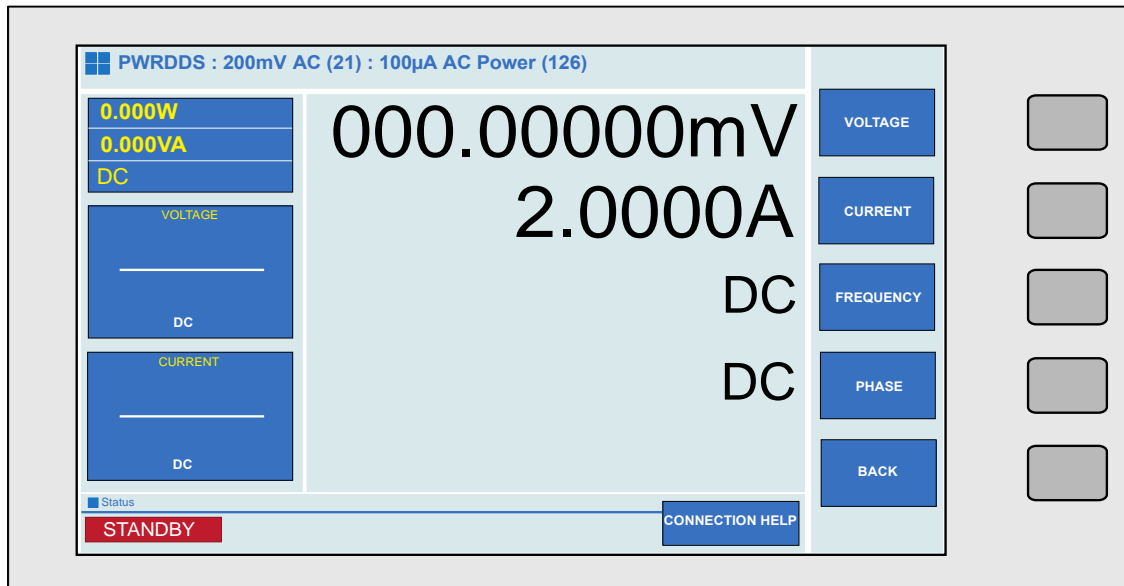

**Figure 72 – DC Power Menu Screen**

- 5) Using the numeric keypad, enter the required voltage value (e.g. 10 V).

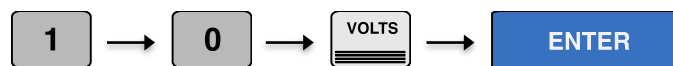

- 6) Then, using the numeric keypad, enter the required current value (e.g. 10 A).



7) Press  to activate the calibrator output.

## 5.24 DDS Power (Option)

The DDS power option is used to simulate harmonics, sags, swells and transients during power output to verify the waveform analysis functions of modern power analysers in addition to Voltage, Current and Phase.

The DDS power option outputs two independent digitally generated waveforms with a high degree of accuracy.

Voltage and current waveform types can be selected directly on the touchscreen (see Figure 73). There are 7 different waveforms available, these are: sine wave, 3<sup>rd</sup> harmonic 5%, 3<sup>rd</sup> harmonic 10%, 5<sup>th</sup> harmonic 5%, 5<sup>th</sup> harmonic 10%, 12<sup>th</sup> harmonic 10% and transient.

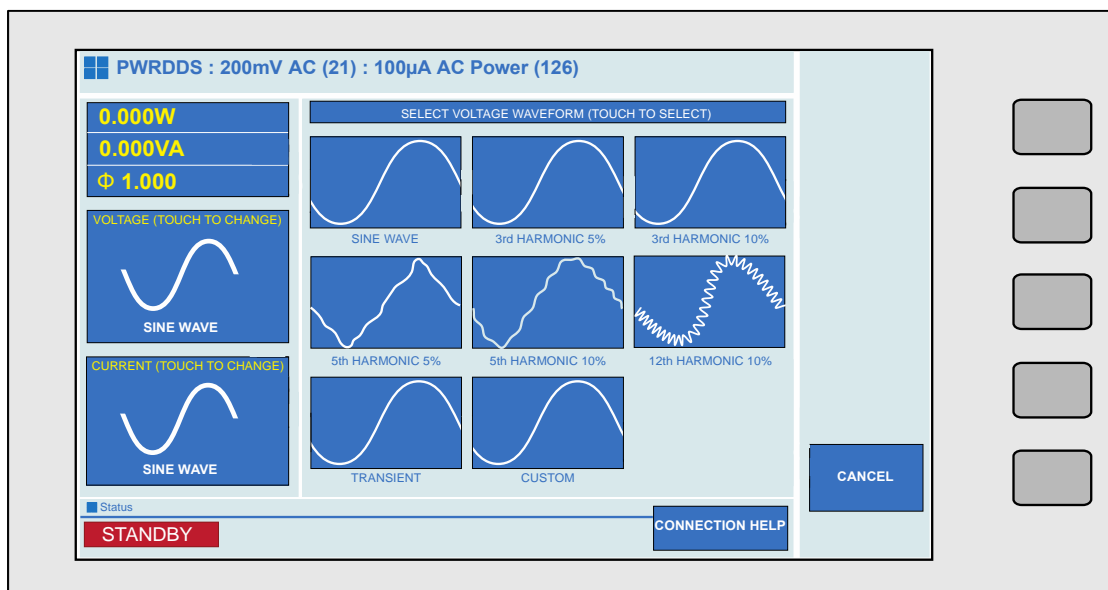

### **Figure 73 – Voltage Waveform Selection Screen**

The custom waveform item is user programmable using the ProWave software supplied with the calibrator. See the ProWave documentation for more details on setting the custom waveform.

To configure the DDS power output, please see the AC Power instructions in Section 5.22 for configuring Voltage, Current, Frequency and phase parameters, and then press either the 'Voltage' or 'Current' waveforms to select the required waveform.

DDS Power will default to Sine wave generation when the function is first entered.

## 5.25 Oscilloscope Calibration Output (Option)

The calibrator provides Amplitude, Timebase and Bandwidth outputs for the calibration of oscilloscopes.

Complete the procedure below to configure oscilloscope calibration mode. If an entry error is made, use the 'backspace' or 'C' (clear) soft keys to edit and delete the entry.

- 1) Connect the meter under test to the 4000 series calibrator as required (see section 4.13 & 4.14 for connection information).
- 2) Ensure the instrument to be calibrated has been set to measure the correct output on the desired range.
- 3) Select 'Functions' using the soft key or touchscreen button.
- 4) Using the digital potentiometer, or by directly touching the required option, select 'Oscilloscope Calibration'. The following should be the oscilloscope functional screen.
- 5) The required output can be selected using the soft keys or touchscreen buttons; this is illustrated in Figure 74. By default, amplitude is selected.

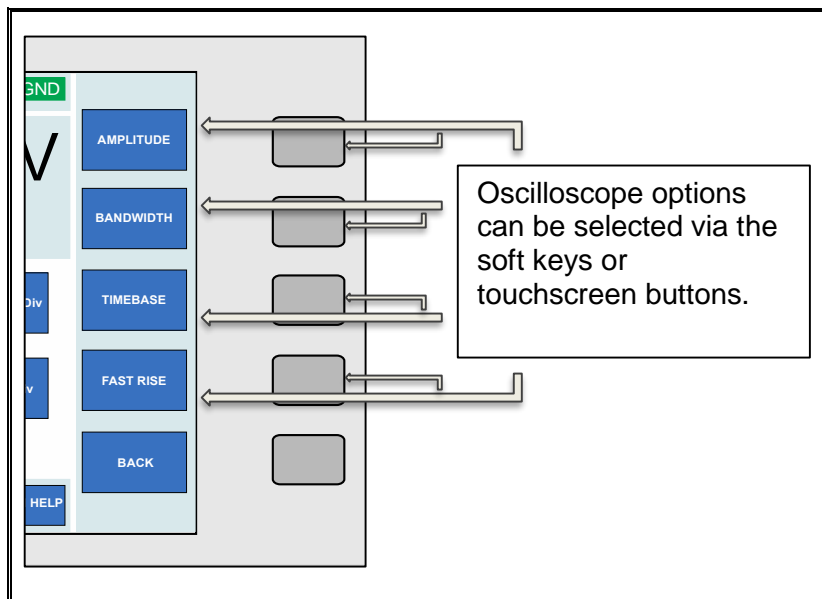

**Figure 74 – Soft Key and Direct Touch Selection for Oscilloscope Options**

- 6) Amplitude ranges can be selected directly from the touchscreen as seen in Figure 75 or by using the 'Range up' and 'Range down' keys.

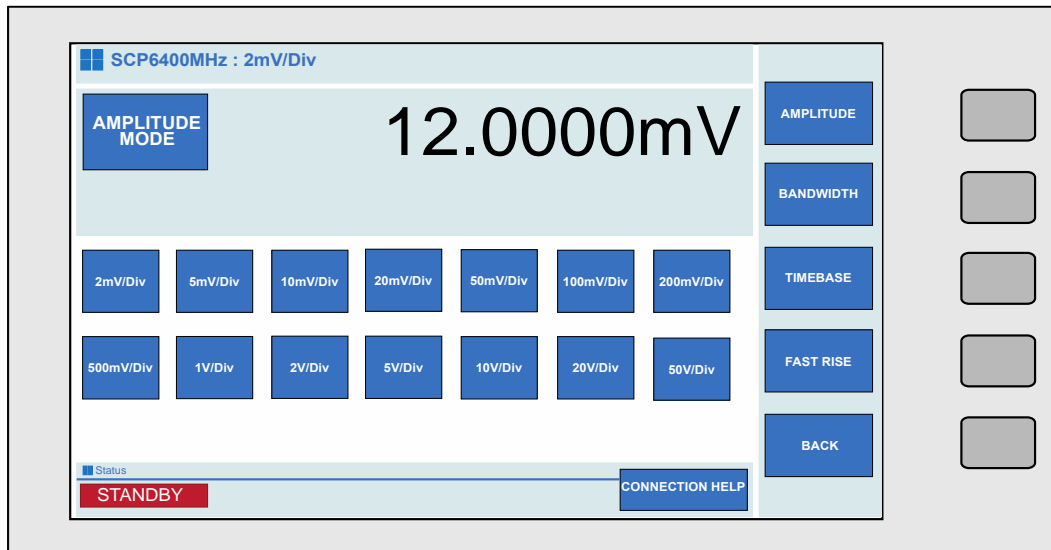

**Figure 75 - Amplitude Mode Screen**

- 7) To select timebase mode press the 'TIMEBASE' soft key or touch button. See Figure 74.
- 8) Timebase ranges can be selected directly from the touchscreen as seen in Figure 76 or by using the 'Range up' and 'Range down' keys.

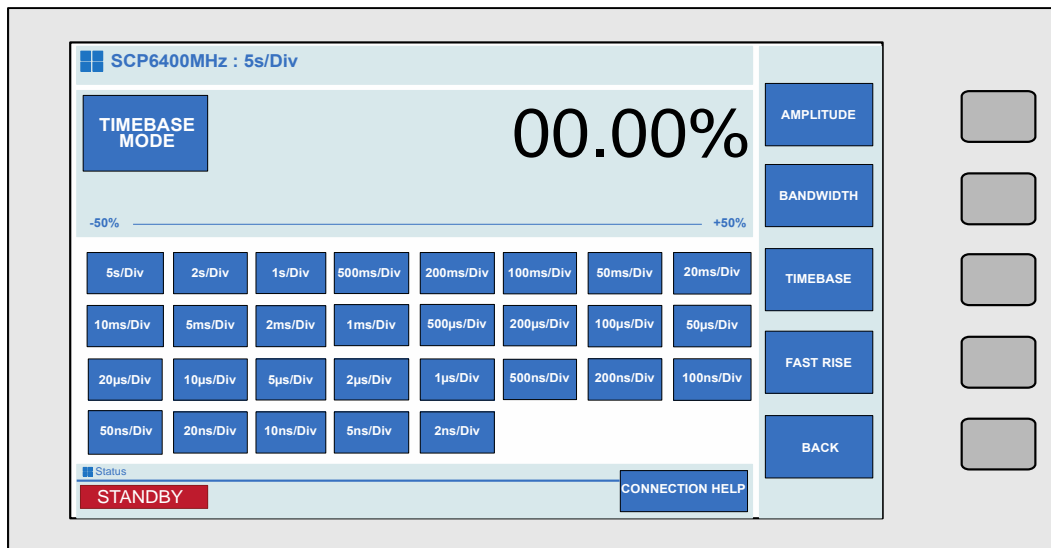

**Figure 76 - Timebase Mode Screen**

- 9) To select the bandwidth function, press the 'BANDWIDTH' soft key or touch button (see Figure 74).
- 10) Bandwidth ranges can be selected directly from the touchscreen as seen in Figure 77 or by using the 'Range up' and 'Range down' keys.

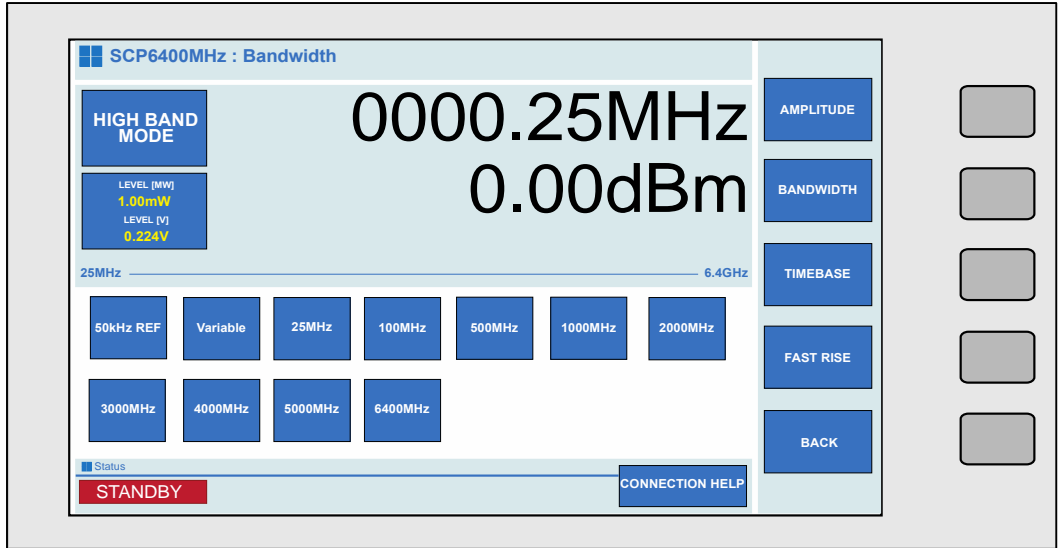

**Figure 77 - Bandwidth Mode Screen**

Bandwidth functions include 50kHz reference output, a variable adjustment mode and ranges from 25MHz to 6.4GHz. A scale bar on the front panel provides a visual representation of the bandwidth range currently selected.

The maximum frequency available depends on the option fitted:

**Table 6 - Scope Options**

Scope Option	Maximum Frequency
SCP250	250MHz
SCP350	350MHz
SCP600	600MHz
SCP6400	6.4GHz

- 11) To adjust the level stroke amplitude, press the 'LEVEL' soft key or touch button.

12) To select the fast rise function, press the 'FAST RISE' soft key or touch button (see Figure 74).

13) Once all required functions and ranges are set, press  to activate the calibrator output.

**For all oscilloscope functions:** To change the required output from the nominal value, the deviation function can be used. This is controlled by using the left and right arrow keys to select the digit to be incremented. To increase or decrease the highlighted digit, use the up and down of the cursor keys or use the digital potentiometer (see section 3.4).



## 6 Procedure Mode

*NOTE: Procedure Mode as of UI version 1.8.5 is under active development. Further features will be added in UI updates enabling additional functionality.*

The 4000 procedure mode enables automated procedures to be run on the 4000 series without the need for control from a computer.

This function is ideal for production lines or environments where IT systems restrict the use of computers.

### 6.1 Creating Procedures

Procedures are created using Transmilles ProEdit software. Using ProEdit a procedure can be written in a matter of minutes using the powerful Wizard.

For further information on ProEdit, please refer to the Transmille website at [www.transmille.com](http://www.transmille.com)

### 6.2 Importing Procedures

Procedures are uploaded to the 4000 Series using the front mounted USB port.

## 7 Verification Mode



*Verification mode is intended for competent laboratories to be able to accelerate the verification and adjustment process of the 4000 Series calibrator. Running adjustment tests will affect the calibration of the instrument, and relies upon the reference multimeter being within specification.*

*Transmille hold no responsibility for incorrect adjustments made using Verification Mode, it is the users responsibility to ensure that reference equipment used is of a suitable standard and accuracy for use with the 4000 series.*

*Verification mode can generate high voltages of up to 1020V AC/DC, as well as currents of up to 30A. Care should be taken at all times and due caution applied.*

*Only qualified operators should initiate verification mode and be aware of the functions and tests that the calibrator will perform.*

*Note : As of UI version 1.8.5 main features of the 4000 Series can be verified/calibrated via the front panel verification mode. Additional features such as Oscilloscope Flatness, Timebase etc. are not possible.*

Verification mode performs a fully traceable verification and/or calibration of the 4000 Series. Rather than the artefact calibration used by other calibrators/references, the method used by the 4000 Series provides traceability though the reference meter and standard used rather than 'black box' methods.

A range of verification procedures are available, many of which can be customised by the operator to verify specific points that may be of particular interest (for example, 7.5V may be required on a production line, so an additional verification test can be added to verify the error at this point rather than the factory defaults)

## 7.1 Equipment Required

Self-verification requires a supported reference multimeter. As of UI version xxx the following meters are supported:

**Table 7 – Supported Reference Multimeters**

Manufacturer	Model
Transmille	8081
Fluke	8508A

For meters that offer only GPIB Interface (i.e. Fluke 8508A) the optional Reference Meter interface must be specified. Multimeters with Serial or USB interfaces can be connected directly to the 4000 series front panel USB port (Serial meters will require a USB to Serial Converter that uses an FTDI chip. These adapters are available from Transmille)

In addition, to verify LCR (Inductance parameters, an LCR meter will be required.

Some multimeters do not offer current measurements up to 30A. In this case external current shunts will be required. Users are free to use their own shunts if they fall within the accuracies required for calibration. Alternatively, Transmille provide a series of AC/DC current shunts with accuracies suitable for performing calibration of the 4000 series. For further information please visit

[www.transmille.com](http://www.transmille.com)

For verification of Frequency outputs, an external frequency reference is required for confirming errors within the measurement device.

## 7.2 Configuring for Measurements

In section 3.13 on Page 43 the process for configuring the Reference Multimeter is explained in detail.

Best practice should be applied for choice of test leads, environmental conditions as well as warm up time of all required equipment.

Only skilled technicians capable of performing the measurements manually should use the Verification Mode, as considerations such as thermals on leads and errors due to test lead resistance cannot be compensated for. Excessive errors due to connection issues will affect the performance of verification mode and cause the 4000 series to be incorrectly adjusted.

## 7.3 Performing Verification

After the 4000 Series has been turned on for at least 4 hours (to achieve best specifications) and all other required test equipment has warmed up to specification verification can be performed.

Ensure that the correct reference multimeter has been configured and connected to the appropriate interface. Instructions for configuring the reference multimeter can be found in Section 3.13 on Page 43

From the Main screen, press 'Menu' to bring up the Main Menu

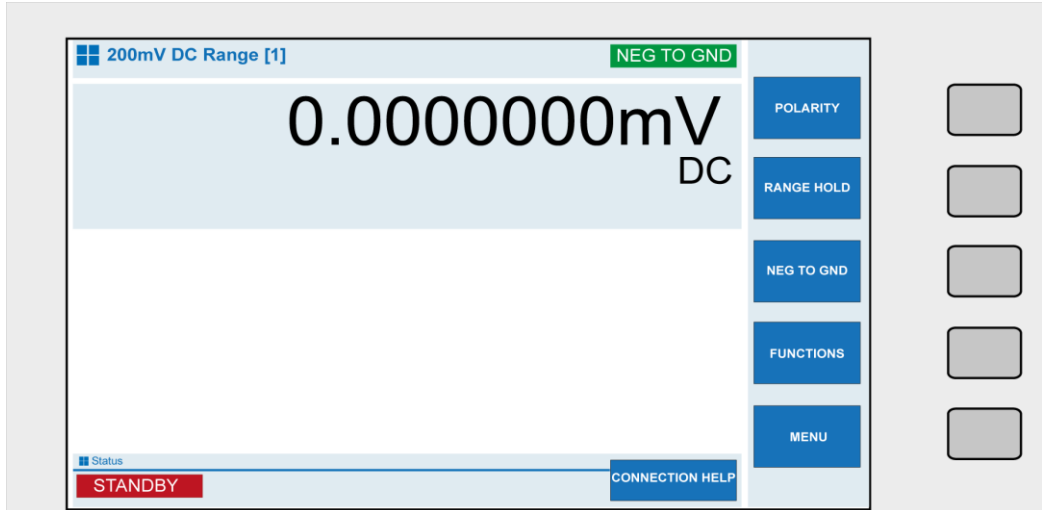

**Figure 78 - 4000 Main Screen**

Select 'Enter Procedure Mode'

From the procedure list, select the verification / adjustment procedure required using the digital control, arrow keys or touchscreen. A verification of just one function (i.e. verify only DC Voltage outputs) or a full verification can be run depending upon the what is required.

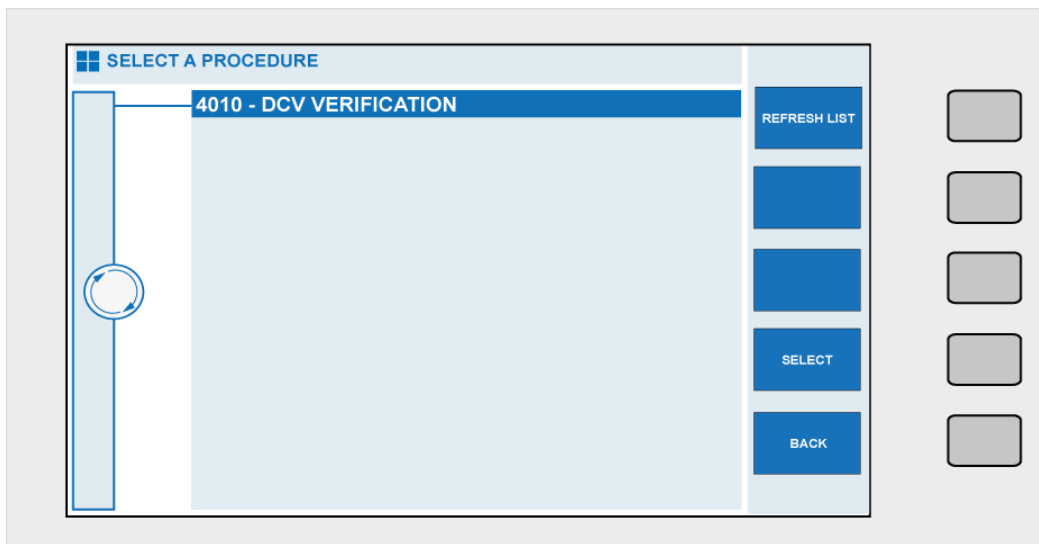

**Figure 79 – Selecting Verification Procedure**

Pressing the 'SELECT' soft key, or the 'ENTER' button will then enter procedure mode and prepare the reference multimeter for measurements.

Verification/Calibration procedures can be configured with prompts to alter the user to changes in connections/outputs, i.e. a prompt may require the user to short the voltage leads from the reference multimeter to perform a voltage zero. These prompts can be turned on and off by selecting (highlighted with a tick). If the box is not ticked, prompts will not show.



**Figure 80 – Pre-Test prompt display toggle**

The Verification/Calibration procedure can be run with or without adjustments by highlighting the checkbox. If the checkbox is selected (highlighted with a tick) adjustment tests in the procedure will run, performing adjustments to the calibration of the 4000 Series.



**Figure 81 – Enable adjustment toggle**

Selecting 'START TESTING' will begin the measurement sequence.

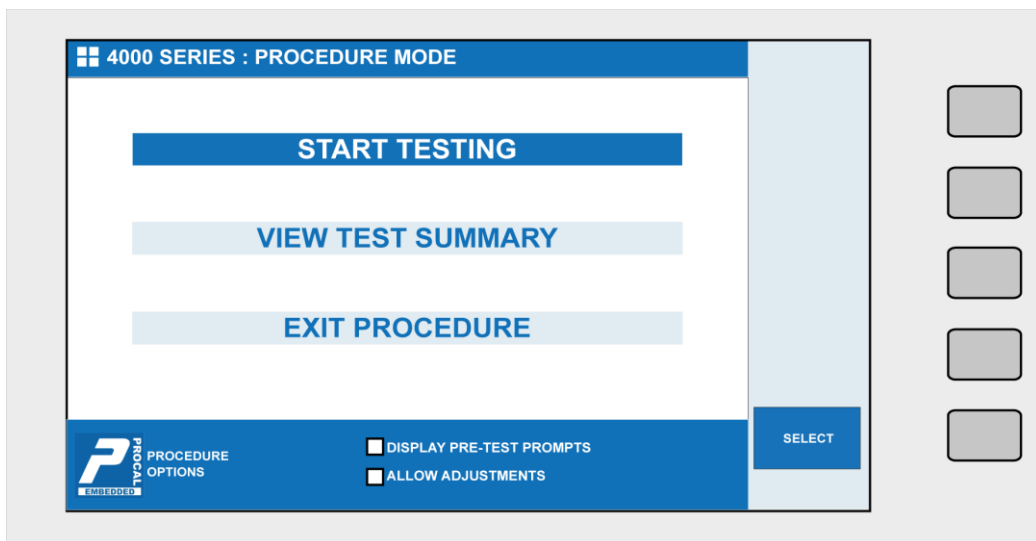

**Figure 82 - Procedure Mode Screen**

If Before-Test prompts have been configured in the verification procedure, prior to measurements starting a pop up screen will appear informing the user of a task to perform (changing lead configuration for example)

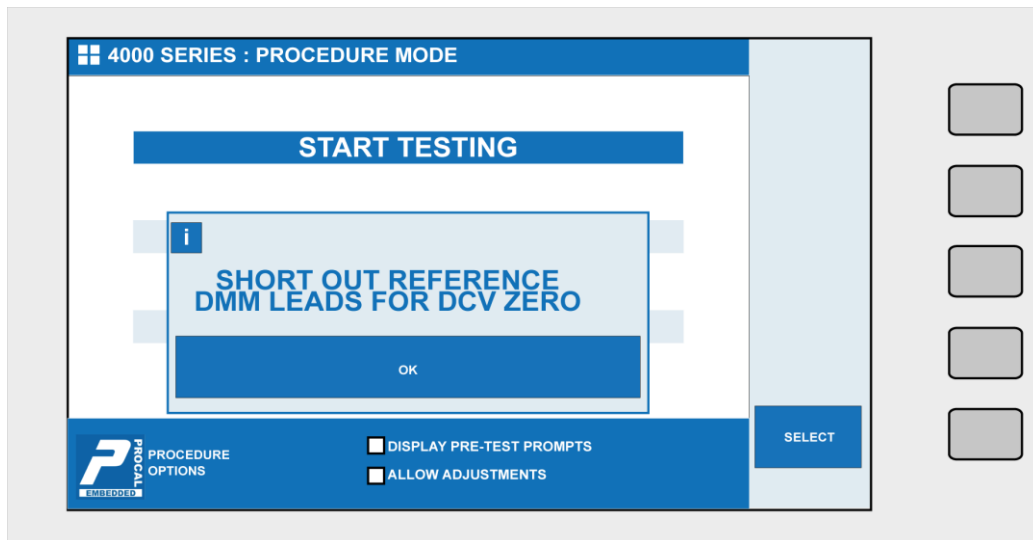
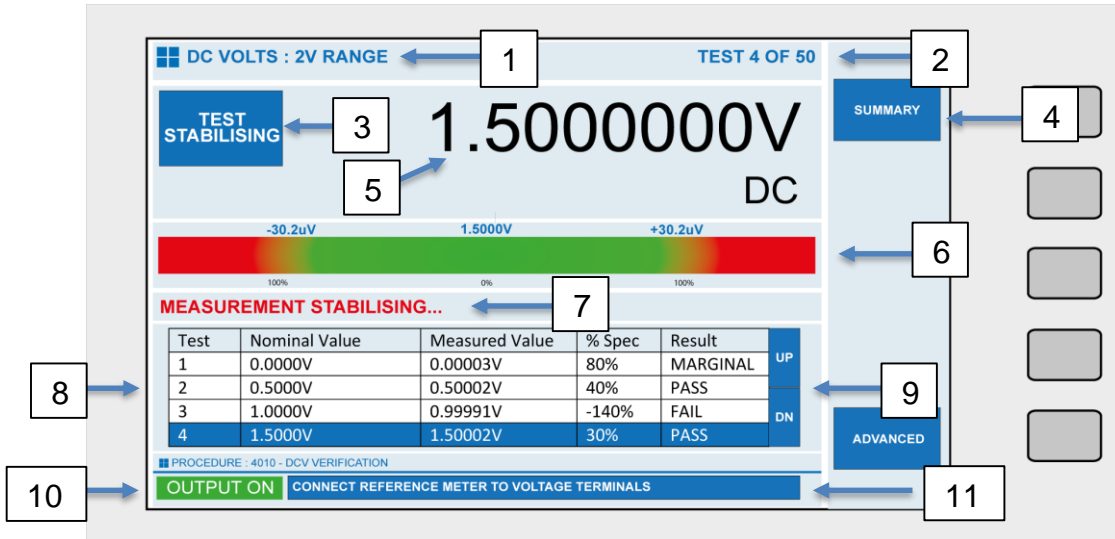

**Figure 83 – Procedure Mode Pre-Test Prompt**

Prompts can appear on the screen if configured within the procedure that is being run. These prompts will require acknowledgement by pressing the 'OK' key that appears in the centre of the screen below the text prompt.

After pressing 'OK' the calibrator will continue with the verification procedure.

The screen will display the measurement mode parameters, with the calibrator output at the top of the screen.



**Figure 84 – Verification Mode Measurement Screen**

**Table 8 – Verification Screen Components**

Label Number	Function
1	Test Title / Description – Provides operator with a description of the test. This is also the title of the test when printed as a certificate / data is exported.
2	Test number – Provides operator with the position in a sequence of tests as well as approximate progress.
3	Measurement Status – This status displays the current measurement state. This status varies upon the current measurement state of measurement.
4	Summary – provides an overview of tests in the procedure, including results for tests that have been completed
5	Calibrator Output – displays the calibrators current output
6	Measurement Bar – Provides the operator with a visual reference of the error in calibrator output. When the arrow indicates that the current result is 'Green', the measurement is within specification. If the measurement arrow indicates 'Amber', the measurement is 'Marginal', when the measurement arrow is in the 'Red', this indicates that the measurement is outside of specification



7	Measurement Status / Averages – The dynamic text displays if the measurement is stabilising, or when stabilised, the number of samples that have been taken and the average of the samples
8	Measurement Table – provides a view of the current and previous measurements that the reference multimeter has obtained. Fields include Test Number, Nominal Value (i.e. calibrator setting), Measured Value (the averaged measurement obtained from the reference multimeter), % of Specification and Test Status (Pass, Marginal, Fail, Not Tested)
9	Up/Down Keys – These keys scroll the measurement table so that previous data can be viewed.
10	Calibrator Status – The indicator here indicates if the output is On or Off. The Standby/Output On LED's on the front panel also indicate the calibrators current status
11	Prompt Text – To remind the operator of the current lead configuration, the last prompt is displayed in this field.

The calibrator will proceed with measurements, allowing time for the measurement to stabilise on both the multimeter and the calibrator, automatically taking averages of the measurements and then proceeding to the next test.

Pressing the 'SUMMARY' soft key will display a view of all of the tests that have been performed during the verification procedure, so that Pass/Fail status can be viewed at any time.

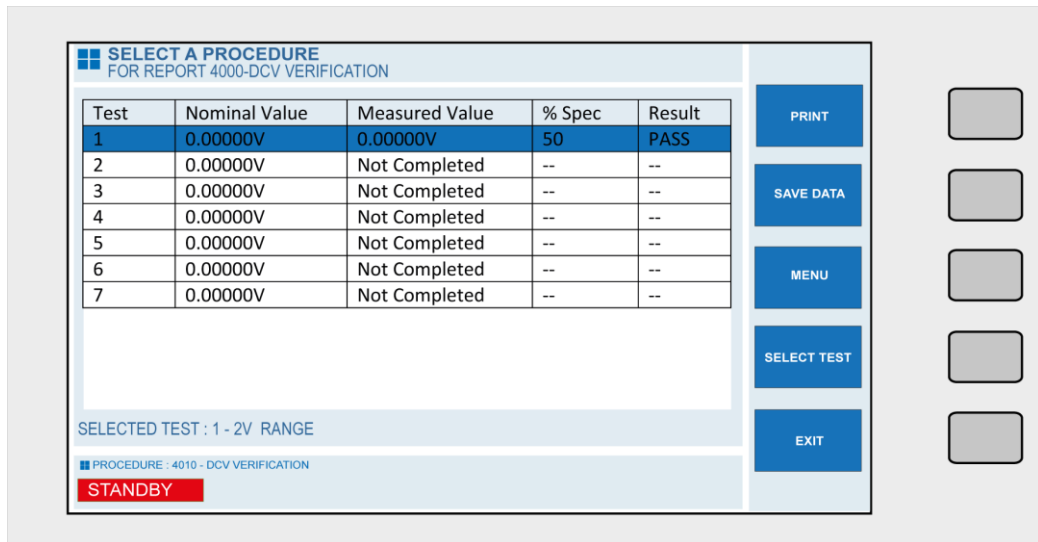

**Figure 85 – Verification Mode Summary View**

From this view all test points in the procedure can be viewed by scrolling up and down using the Digital Control.

When the test is highlighted (as in Figure 85), pressing the 'SELECT TEST' key will re-run the verification tests from the selected test.

Pressing 'PRINT' will print out a test report via a PCL compatible printer that has been connected via the Front Panel USB connector.

Pressing the 'SAVE DATA' key will save the current verification procedure as a new test report. The Test Report is saved under an automatically generated number. This number can be changed by following the procedure in Section 3.12 on Page 40.

Pressing 'MENU' will return the 4000 Series to the Procedure Mode home screen, and pressing 'EXIT' will return the 4000 Series to the main screen, exiting Procedure Mode.

If the test report has not been saved, a prompt will appear on the screen prompting if the user wishes to save the test report or to discard results.

## 8 Remote Programming

### WARNING



*The 4000 Series Calibrator can produce high voltages up to 1025V and must be programmed with due caution to prevent dangerous voltages from being present at the output terminals without warning to the operator.*

*Any programs should be extensively tested to maintain safe operation and include safeguard's such as error catchments and handling to ensure that any commands sent to the calibrator perform as expected and any that do not are safely handled to ensure user safety.*

*Within the 4000 series command language, response codes are included to determine the operational state of the calibrator. These response codes can also be used to determine whether a command was received correctly and thus ensuring safe operation of the calibrator.*

*Due to continual improvement, commands are subject to change, with features either added or removed. Although all efforts will be made to retain backwards compatibility with previous commands, this cannot be guaranteed. All commands are correct as of firmware version 13.0.25*

## 8.1 Response / Error Codes

The 4000 Series calibrators will respond to any command with a fixed code beginning with a star (\*) - the codes are listed below

**Table 9 – 4000 Series Response / Error Code Description**

<b>Response Code</b>	<b>Description</b>
*0	Command Successful
*1	Unrecognised Command
*2	Invalid Range
*3	Invalid Frequency
*4	Invalid Output Value
*5	Invalid Calibration Factor
*6	Unauthorised Command
*7	Correct command, incorrect data
*8	High Voltage Timeout
*9	Output Error
*10	I-Guard Voltage Detected
*11	High Current Over Temperature
*12	High Current Timeout
*13	Current Over Compliance
*14	Output Overload
*15	Simulated Resistance – Terminal voltage in excess of specification
*16	Simulated Resistance – Input Current in excess of specification
*17	Simulated Resistance – Offset compensation failed

All status/error responses are followed by <CR><LF>, and are send over the interface even when in Local front panel control.

## 8.2 Legacy Commands

To maintain compatibility with 3000A Series Calibrators, the 4000 Series command language features both new commands for 4000 Series Functions, as well as backwards compatible commands for use in existing programs.

If the 4000 Series is used with ProCal, the built in drivers automatically support new functions of the 4000 Series Calibrator.

## 8.3 Programming Commands Overview

The 4000 Series calibrators are controlled by a set of simple high level commands which can be used either individually or as part of a command sequence.

The required terminator for the commands to be detected by the calibrator is a carriage return (ASCII character 13) and should be the last character sent on a command line.

For Example:

**{Command}{Data}<CR>**

Where the command is represented as **{Command}**, the required value as **{Data}** and the carriage return (ASCII character 13) is represented by **<CR>**

## 8.4 Compound Commands

To simplify remote commands, multiple commands can be sent in a single line of instructions. This can reduce the number of lines required in a program to configure the output of the calibrator.

The separator '/' (backslash) should be used between each command/data pair, as in Figure 86.

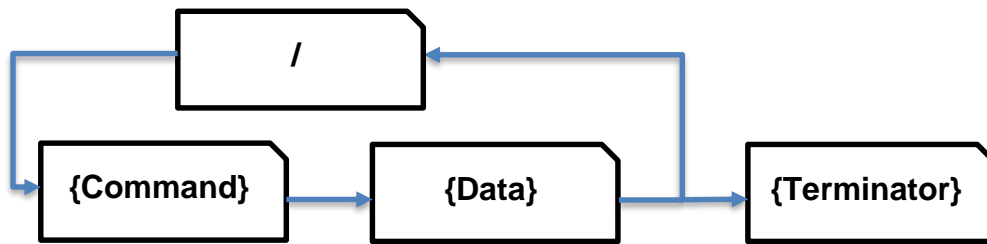

**Figure 86 – Compound Command Schema**

An example of the use of this would be setting Range 1 (r1) for 200mV DC Voltage, with an output of 100mV (O100), followed by turning the output on (S0)

```
r1/O100/S0<CR>
```

These commands do not need additional delays between and can simplify the setting of outputs.

## 8.5 Output State

The output status of the 4000 Series Calibrator can be configured with the following commands:

Standby Mode	
Standby ON	S1
Standby OFF	S0

To turn output ON, set standby to OFF e.g. r1/O100/S0<CR>

## 8.6 DC Voltage Commands

Function	Range	Command	Legacy Command
DC Voltage	200mV	r1	R1
	2V	r2	R2
	20V	r3	R3
	200V	r4	R4
	1000V	r5	R5
	10kV (EA3024)	r5	R5

Standby Mode	
Standby ON	S1
Standby OFF	S0

Output	
Set Output	O (not zero)

The DC voltage section consists of a set of range commands which are used in conjunction with the standby and output command. To enable a DC Voltage to be set and an output assigned, the following command sequence should be used:

**{RANGE}/{OUTPUT}/{STANDBY CONDITION}<CR>**

For example, to assign 2V D.C. with the output switched on, the command is:

**r2/O2/S0<CR>**

r2 = 2V Range (as detailed in the table above)

O2 = 2V Output

S0 = Standby OFF (i.e. output switched ON)

<CR> = Carriage Return (ASCII character 13)

Additional examples:

150mV DC      r1/O150/S0<CR>      (sets 150mV output on the 200mV range)

22V DC          r3/O22/S0<CR>      (sets 22V output on the 200V range)

If a command includes a value which cannot be set due to, for example, the value being higher than the range maximum, the calibrator will reject the command and stay set as it is (the calibrator will also beep to signify a rejected command)

The calibrator will respond to the commands sent with the response codes as detailed at the beginning of this section. These codes can be used to ensure that hazardous output conditions are clearly indicated to the operator and to maintain control of these outputs. This allows the calibrator to be returned to a safe state once the testing required has been completed (e.g. setting the calibrator back to standby once a test is complete and ensuring this has been successfully achieved and no hazardous outputs remain on the terminals).

This functionality is employed within the ProCal calibration software from Transmille to allow safe operation of the calibrator and to ensure the calibrator is returned to a safe state in between test points and at the completion of a test sequence.



## 8.7 AC Voltage Commands

Function	Range	Command	Legacy Command
AC Voltage	200mV	r21	R12
	2V	r22	R13
	20V	r23	R14
	200V	r24	R15
	1000V	r25	R16
	10kV (EA3024)	r26	

Standby Mode	
Standby ON	S1
Standby OFF	S0

Output	
Set Output	O (not zero)

AC Frequency	
Fxxxxx	E.G. 10kHz = F10000

The AC voltage section consists of a set of range commands which are used in conjunction with the standby and output command. To enable an AC Voltage to be set and an output assigned, the following command sequence should be used:

<RANGE>/<OUTPUT>/<FREQUENCY>/<STANDBY CONDITION><CR>

For example, to get 2V @ 200Hz AC with the output switched on, the command is:

r2/O2/F200/S0<CR>

r13 = 2V AC Range (as detailed in the table above)

O2 = 2V Output

F200 = 200Hz Frequency

S0 = Standby OFF (i.e. output switched ON)

<CR> = Carriage Return (ASCII character 13)

### **8.7.1 Additional examples:**

135mV @ 10kHz AC

```
r12/O135/F10000/S0<CR>
```

(sets 135mV @ 10kHz output on the 200mV range)

255V @ 15kHz AC

```
r16/O255/F15000/S0<CR>
```

(sets 255V @ 15kHz output on the 1000V range)

If a command includes a value which cannot be set due to, for example, the value being higher than the range maximum, the calibrator will reject the command and stay set as it is (the calibrator will also beep to signify a rejected command)

The calibrator will respond to the commands sent with the response codes as detailed at the beginning of this section. These codes can be used to ensure that hazardous output conditions are clearly indicated to the operator and to maintain control of these outputs. This allows the calibrator to be returned to a safe state once the testing required has been completed (e.g. Setting the calibrator back to standby once a test is complete and ensuring this has been successfully achieved and no hazardous outputs remain on the terminals).

This functionality is employed within the ProCal calibration software from Transmille to allow safe operation of the calibrator and to ensure the calibrator is returned to a safe state in between test points and at the completion of a test sequence.

## 8.8 DC Current Commands

Function	Range	Command	Legacy Command
DC Current	200uA	r11	R6
	2mA	r12	R7
	20mA	r13	R8
	200mA	r14	R9
	2A	r15	R10
	30A	r16	R11

Standby Mode	
Standby ON	S1
Standby OFF	S0

Output	
Set Output	O (not zero)

The DC current section consists of a set of range commands which are used in conjunction with the standby and output command. To enable a DC current to be set and an output assigned, the following command sequence should be used:

`<RANGE>/<OUTPUT>/<STANDBY CONDITION><CR>`

For example, to get 20mA DC with the output switched on, the command is:

`r13/O20/S0<CR>`

r13 = 20mA Range (as detailed in the table above)

O2 = 20mA Output

S0 = Standby OFF (i.e. output switched ON)

<CR> = Carriage Return (ASCII character 13)

Additional examples:

25mA DC r14/O25/S0<CR> (sets 25mA output on the 200mA range)

12A DC r16/O12/S0<CR> (sets 12A output on the 30A range)

If a command includes a value which cannot be set due to, for example, the value being higher than the range maximum, the calibrator will reject the command and stay set as it is (the calibrator will also beep to signify a rejected command)

The calibrator will respond to the commands sent with the response codes as detailed at the beginning of this section. These codes can be used to ensure that hazardous output conditions are clearly indicated to the operator and to maintain control of these outputs. This allows the calibrator to be returned to a safe state once the testing required has been completed (e.g. Setting the calibrator back to standby once a test is complete and ensuring this has been successfully achieved and no hazardous outputs remain on the terminals).

This functionality is employed within the ProCal calibration software from Transmille to allow safe operation of the calibrator and to ensure the calibrator is returned to a safe state in between test points and at the completion of a test sequence.

## 8.9 AC Current Commands

Function	Range	Command	Legacy Command
AC Current	200uA	r31	R17
	2mA	r32	R18
	20mA	r33	R19
	200mA	r34	R20
	2A	r35	R21
	30A	r36	R22

Standby Mode	
Standby ON	S1
Standby OFF	S0

Output	
Set Output	O (not zero)

AC Frequency	
Fxxxxx	E.G. 10kHz = F10000

The AC current section consists of a set of range commands which are used in conjunction with the standby and output command. To enable a AC current to be set and an output assigned, the following command sequence should be used:

<RANGE>/<OUTPUT>/<FREQUENCY>/<STANDBY CONDITION><CR>

For example, to get 20mA @ 1 kHz AC with the output switched on, the command is:

r33/O20/F1000/S0<CR>

r33 = 20mA Range (as detailed in the table above)

O2 = 20mA Output

F1000 = 1 kHz Frequency

S0 = Standby OFF (i.e. output switched ON)

<CR> = Carriage Return (ASCII character 13)

Additional examples:

25mA @ 1.5 kHz AC

r34/O25/F1500/S0<CR>

(sets 25mA @ 1.5kHz output on the 200mA range)

12A AC @ 300 Hz

r36/O12/F300/S0<CR>

(Sets 12A @ 300Hz output on the 20A range)

If a command includes a value which cannot be set due to, for example, the value being higher than the range maximum, the calibrator will reject the command and stay set as it is (the calibrator will also beep to signify a rejected command)

The calibrator will respond to the commands sent with the response codes as detailed at the beginning of this section. These codes can be used to ensure that hazardous output conditions are clearly indicated to the operator and to maintain control of these outputs. This allows the calibrator to be returned to a safe state once the testing required has been completed (e.g. Setting the calibrator back to standby once a test is complete and ensuring this has been successfully achieved and no hazardous outputs remain on the terminals).

This functionality is employed within the ProCal calibration software from Transmille to allow safe operation of the calibrator and to ensure the calibrator is returned to a safe state in between test points and at the completion of a test sequence.

## 8.10 Passive Resistance Commands

Function	Range	Command	Legacy Command
Resistance	0 Ohms	r41	R23
	0.1 Ohms	r42	R24
	1 Ohms	r43	R25
	10 Ohms	r44	R26
	100 Ohms	r45	R27
	1 kOhm	r46	R28
	10 kOhms	r47	R29
	100 kOhms	r48	R30
	1 MOhms	r49	R31
	10 MOhms	r50	R32
	100 MOhms	r51	R33
	1G Ohms	r52	R65

Standby Mode	
Standby ON	S1
Standby OFF	S0

2 / 4 Wire Resistance	
2 Wire	I0
4 Wire	I1

The resistance section consists of a set of range commands which are used in conjunction with the 2 or 4 Wire mode and standby commands. To enable a DC resistance to be set, the following command sequence should be used:

<RANGE>/<2 OR 4 WIRE MODE>/<STANDBY CONDITION><CR>

The use of the output (O) command is not necessary as the resistance ranges are fixed ranges at decade points.

For example, to set the 1kOhm range 2-Wire output with the output switched on, the command is:

```
r46/I0/S0<CR>
```

r46 = 1KOhm Range (as detailed in the table above)

I0 = 2 Wire mode

S0 = Standby OFF (i.e. output switched ON)

<CR> = Carriage Return (ASCII character 13)

Additional examples:

1 kOhm 4-Wire

```
r46/I1/S0<CR>
```

10 MOhm 2-Wire

```
r49/I0/S0<CR>
```

The calibrator will respond to the commands sent with the response codes as detailed at the beginning of this section. These codes can be used to ensure that hazardous output conditions are clearly indicated to the operator and to maintain control of these outputs. This allows the calibrator to be returned to a safe state once the testing required has been completed (e.g. setting the calibrator back to standby once a test is complete and ensuring this has been successfully achieved and no hazardous outputs remain on the terminals).

This functionality is employed within the ProCal calibration software from Transmille to allow safe operation of the calibrator and to ensure the calibrator is returned to a safe state in between test points and at the completion of a test sequence.



## 8.11 Passive Capacitance Commands

Function	Range	Command	Legacy Command
Capacitance	1nF	r61	R34
	2nF	r62	R35
	5nF	r63	R36
	10nF	r64	R37
	100nF	r65	R38
	1uF	r66	R39
	10uF	r67	R40

Standby Mode	
Standby ON	S1
Standby OFF	S0

The capacitance section consists of a set of range commands which are used in conjunction with the standby command. To enable a capacitance to be set, the following command sequence should be used:

<RANGE>/<STANDBY CONDITION><CR>

The use of the output (O) command is not necessary as the capacitance ranges are fixed ranges at decade points.

For example, to set the 10nF output with the output switched on, the command is:

r64/S0<CR>

r64 = 10nF Range (as detailed in the table above)

S0 = Standby OFF (i.e. output switched ON)

<CR> = Carriage Return (ASCII character 13)

## 8.12 Simulated Resistance Commands (Option)

Function	Range	Command	Legacy Command
Resistance	100 Ohms	r164	I2/R27
	330 Ohms	r165	N/A
	1 kOhm	r166	I2/R28
	3.3 kOhms	r167	N/A
	10 kOhms	r168	I2/R29
	33 kOhms	r169	N/A
	100 kOhms	r170	I2/R30
	330 kOhms	r171	N/A
	1 MOhms	r172	I2/R31
	3.3 MOhms	r173	N/A
	10 MOhms	r174	I2/R32
	33 MOhms	r175	N/A
	100 MOhms	r176	N/A
	330 MOhms	r177	N/A
	1G Ohms	r178	N/A

Standby Mode	
Standby ON	S1
Standby OFF	S0

Output	
Set Output	O (not zero)

The resistance section consists of a set of range commands which are used in conjunction with the standby command. To enable a capacitance to be set, the following command sequence should be used:

**<RANGE>/<OUTPUT>/<STANDBY CONDITION><CR>**

## Examples:

8 kOhms	450 MOhms	60 Ohms
<b>r168/O8/S0&lt;CR&gt;</b>	<b>r178/O0.45/S0&lt;CR&gt;</b>	<b>r164/O60/S0&lt;CR&gt;</b>
r168 = 3.3 kOhm – 10 kOhm Range O8 = 8 kOhms Output S0 = Standby OFF (i.e. output ON) <CR> = Carriage Return (ASCII 13)	r178 = 330MOhms – 1 GOhms Range O450 = 0.45 GOhms Output S0 = Standby OFF (i.e. output ON) <CR> = Carriage Return (ASCII 13)	r164 = 0 Ohms – 100 Ohms Range O60 = 60 Ohms Output S0 = Standby OFF (i.e. output ON) <CR> = Carriage Return (ASCII 13)

## 8.13 Variable Capacitance Commands (Option)

Function	Range	Command	Legacy Command
Capacitance	0.95uF - 9.5uF	r193	N/A
	9.5 – 95uF	r195	N/A
	95uf – 950uF	r197	N/A
	0.95mF – 9.5mF	r199	N/A
	9.5mF – 100mF	r201	N/A

Standby Mode	
Standby ON	S1
Standby OFF	S0

Output	
Set Output	O (not zero)

The capacitance section consists of a set of range commands which are used in conjunction with the standby command. To enable a capacitance to be set, the following command sequence should be used:

**<RANGE>/<OUTPUT>/<STANDBY CONDITION><CR>**

For example, to set an output of 1.2 mF with the output switched on, the command is:

**r199/O1.2/S0<CR>**

r199 = 0.95mF to 9.5mF Range (as detailed in the table above)

O1.2 = Output of 1.2mF

S0 = Standby OFF (i.e. output switched ON)

<CR> = Carriage Return (ASCII character 13)

10 uF	40mF
<b>r195/O10/S0&lt;CR&gt;</b>	<b>r201/O40/S0&lt;CR&gt;</b>
r195 = 9.5uF – 95uF Range O10 = 10 uF Output S0 = Standby OFF (i.e. output ON) <CR> = Carriage Return (ASCII 13)	r201 = 9.5mF – 100mF Range O450 = 40 mF Output S0 = Standby OFF (i.e. output ON) <CR> = Carriage Return (ASCII 13)

## 8.14 Frequency Commands (Option)

Function	Mode Activation Command	
Frequency	R58	
	Preset Values	Command
	1Hz	H0
	10Hz	H1
	100Hz	H2
	1kHz	H3
	10kHz	H4
	20kHz	H5
	50kHz	H6
	100kHz	H7
	1MHz	H8
	10MHz	H9

Standby Mode	
Standby ON	S1
Standby OFF	S0

The frequency section consists of a mode activation command followed by a set of range commands which are used in conjunction with the standby command. To enable a frequency to be set, the following command sequence should be used:

<MODE>/<PRESET OR (O) FREQUENCY>/<STANDBY CONDITION><CR>

The use of the output (O) command enables the frequency to be set from 1Hz to 1MHz in 1Hz steps.

For example, to set the 10 kHz output with the output switched on, the command would be:

R58/H4/S0<CR>

R58 = Frequency Mode Activation (as detailed in the table above)

H4 = 10 kHz output (as detailed in the table above)

S0 = Standby OFF (i.e. output switched ON)

<CR> = Carriage Return (ASCII character 13)

To set a frequency other than a preset the following command line would be used, for example 15 kHz output with the output switched on:

R58/O15000/S0<CR>

R58 = Frequency Mode Activation (as detailed in the table above)

O15000 = 15 kHz output

S0 = Standby OFF (i.e. output switched ON)

<CR> = Carriage Return (ASCII character 13)

Additional examples:

1 Hz      R58/H0/S0<CR>

100 kHz   R58/H7/S0<CR>

The calibrator will respond to the commands sent with the response codes as detailed at the beginning of this section. These codes can be used to ensure that hazardous output conditions are clearly indicated to the operator and to maintain control of these outputs. This allows the calibrator to be returned to a safe state once the testing required has been completed (e.g. Setting the calibrator back to standby once a test is complete and ensuring this has been successfully achieved and no hazardous outputs remain on the terminals).

This functionality is employed within the ProCal calibration software from Transmille to allow safe operation of the calibrator and to ensure the calibrator is returned to a safe state in between test points and at the completion of a test sequence.

## 8.15 Pulse Width Modulation Commands (Option)

Function	Mode Activation Command	
Pulse Width Modulation	R59	
	Preset Values	Command
	10%	H0
	20%	H1
	30%	H2
	40%	H3
	50%	H4
	60%	H5
	70%	H6
	80%	H7
	90%	H8

Frequency	
Fxxxxx	e.g. 1kHz = F1000

Standby Mode	
Standby ON	S1
Standby OFF	S0

The pulse width modulation section consists of a mode activation command followed by a set of range commands which are used in conjunction with the standby command. To enable a pulse width modulation to be set, the following command sequence should be used:

<MODE>/<FREQUENCY>/<PRESET OR (O) PERCENTAGE>/<STANDBY CONDITION><CR>



The frequency can be set from 100 Hz to 10 kHz in 1Hz steps. The use of the output (O) command enables the pulse width modulation to be set from 1% to 99% in 1% steps or the preset values can be used e.g. H0 = 10%

For example, to set the 10% output with the output switched on, the command is:

```
R59/F1000/H0/S0<CR>
```

R59 = Pulse width modulation Mode Activation (as detailed in the table above)

F1000 = Frequency 1 kHz (1000 Hz)

H0 = 10% output (as detailed in the table above)

S0 = Standby OFF (i.e. output switched ON)

<CR> = Carriage Return (ASCII character 13)

To set a pulse width other than a preset the following command line would be used, for example 47% output at 7 kHz with the output switched on:

```
R59/F7000/O47/S0<CR>
```

R59 = Pulse width modulation Mode Activation (as detailed in the table above)

F7000 = Frequency 7 kHz (7000 Hz)

O47 = 47% output

S0 = Standby OFF (i.e. output switched ON)

<CR> = Carriage Return (ASCII character 13)

Additional example

```
100 Hz @ 40%      R59/F100/H3/S0<CR>
```

The calibrator will respond to the commands sent with the response codes as detailed at the beginning of this section. These codes can be used to ensure that hazardous output conditions are clearly indicated to the operator and to maintain control of these outputs. This allows the calibrator to be returned to a safe state once the testing required has been completed (e.g. setting the calibrator back to

standby once a test is complete and ensuring this has been successfully achieved and no hazardous outputs remain on the terminals).

This functionality is employed within the ProCal calibration software from Transmille to allow safe operation of the calibrator and to ensure the calibrator is returned to a safe state in between test points and at the completion of a test sequence.

## 8.16 Inductance Commands (Option)

Function	Range	Command	Legacy Command
Inductance	1mH	r76	R42
	10mH	r77	R43
	19mH	r78	R44
	29mH	r79	R45
	50mH	r80	R46
	100mH	r81	R47
	1H	r82	R48
	10H	r83	R49

Standby Mode	
Standby ON	S1
Standby OFF	S0

The inductance section consists of a set of range commands which are used in conjunction with the standby command. To enable an inductance to be set, the following command sequence should be used:

<RANGE>/<STANDBY CONDITION><CR>

The use of the output (O) command is not necessary as the inductance ranges are fixed ranges at decade points.

For example, to set the 29mH output with the output switched on, the command is :

r79/S0<CR>

r79 = 29mH Range (as detailed in the table above)

S0 = Standby OFF (i.e. output switched ON)

<CR> = Carriage Return (ASCII character 13)

Additional examples:

10mH     r77/S0<CR>

1H        r82/S0<CR>

The calibrator will respond to the commands sent with the response codes as detailed at the beginning of this section. These codes can be used to ensure that hazardous output conditions are clearly indicated to the operator and to maintain control of these outputs. This allows the calibrator to be returned to a safe state once the testing required has been completed (e.g. Setting the calibrator back to standby once a test is complete and ensuring this has been successfully achieved and no hazardous outputs remain on the terminals).

This functionality is employed within the ProCal calibration software from Transmille to allow safe operation of the calibrator and to ensure the calibrator is returned to a safe state in between test points and at the completion of a test sequence.

## 8.17 Passive PRT Commands (Option)

Function	Range	Command	Legacy Command
PRT Value	-100°C	r86	R50
	0°C	r87	R51
	30°C	r88	R52
	60°C	r89	R53
	100°C	r90	R54
	200°C	r91	R55
	300°C	r92	R56
	400°C	r93	R57

Standby Mode	
Standby ON	S1
Standby OFF	S0

The PRT section consists of a set of range commands which are used in conjunction with the standby command. To enable a PRT value to be set, the following command sequence should be used:

<RANGE>/<STANDBY CONDITION><CR>

The use of the output (O) command is not necessary as the PRT ranges are fixed output ranges.

For example, to set the 60°C output with the output switched on, the command is:

```
r89/S0<CR>
```

r89 = 60°C Range (as detailed in the table above)

S0 = Standby OFF (i.e. output switched ON)

<CR> = Carriage Return (ASCII character 13)

Additional examples:

```
200°C      r91/S0<CR>
```

```
400°C      r93/S0<CR>
```

The calibrator will respond to the commands sent with the response codes as detailed at the beginning of this section. These codes can be used to ensure that hazardous output conditions are clearly indicated to the operator and to maintain control of these outputs. This allows the calibrator to be returned to a safe state once the testing required has been completed (e.g. Setting the calibrator back to standby once a test is complete and ensuring this has been successfully achieved and no hazardous outputs remain on the terminals).

This functionality is employed within the ProCal calibration software from Transmille to allow safe operation of the calibrator and to ensure the calibrator is returned to a safe state in between test points and at the completion of a test sequence.

## 8.18 Variable PRT Commands (Option)

Function	Range	Command	Legacy Command
Variable PRT	<auto>	r95	N/A

Standby Mode	
Standby ON	S1
Standby OFF	S0

R0	
Set R0 Value (25 Ohm, 100 Ohm (default), 500 Ohms, 1kOhm)	PRTZERO

Output	
Set Output	O (not zero)

The variable PRT output consists of a range command, the R0 value, and the output value which are used in conjunction with the standby command. To enable an output to be set, the following command sequence should be used:

<RANGE>/<R0>/<OUTPUT>/<STANDBY CONDITION><CR>

For example, to set the 100°C with an R0 of 100 Ohms with the output switched on, the command is:

**r95/PRTZERO100/O100/S0<CR>**

r95 = Variable PRT Function

PRTZERO100 = Set the R0 reference to 100 Ohms

O100 = set the output to 100°C

S0 = Standby OFF (i.e. output switched ON)

<CR> = Carriage Return (ASCII character 13)

Additional examples:

317.5°C with an R0 of 250 Ohms

**r95/PRTZERO250/O317.5/S0<CR>**

The calibrator will respond to the commands sent with the response codes as detailed at the beginning of this section. These codes can be used to ensure that hazardous output conditions are clearly indicated to the operator and to maintain control of these outputs. This allows the calibrator to be returned to a safe state once the testing required has been completed (e.g. setting the calibrator back to standby once a test is complete and ensuring this has been successfully achieved and no hazardous outputs remain on the terminals).

This functionality is employed within the ProCal calibration software from Transmille to allow safe operation of the calibrator and to ensure the calibrator is returned to a safe state in between test points and at the completion of a test sequence.



## 8.19 Thermocouple Simulation Commands (Option)

This function requires the use of the optional EA001A Thermocouple simulation adapter. This is used in conjunction with the adapter interface connection on the 4000 Series to provide the thermocouple simulation.

Function	Command	Legacy Command
Thermocouple Simulation	r98	R60

Range	Command	Legacy Command
Type K	LK	L1
Type J	LJ	L2
Type T	LT	L3
Type R	LR	L4
Type S	LS	L5
Type E	LE	L6
Type N	LN	L7
Type B	LB	L8
Type U	LU	N/A
Type C	LC	N/A
Linear (1mV / °C)	Lm	N/A

Cold Junction	
Manual Cold Junction (0°C)	K0
Auto Cold Junction	K1
Manual Cold Junction settable	KT<value>

Output	
Set Output	O (not zero)

Standby Mode
--------------

Standby ON	S1
Standby OFF	S0

The thermocouple simulation function consists of the following commands:

- 1) Thermocouple simulation mode activation
- 2) Thermocouple cold junction type
- 3) Thermocouple type command
- 4) Thermocouple output value
- 5) Standby mode command

To enable thermocouple simulation to be set up, the following command sequence should be used:

```
<MODE>/<CJC TYPE>/<THERMO TYPE>/<TEMP VALUE>/
<STANDBY CONDITION><CR>
```

For example, to set the following configuration:

- 1) AUTOMATIC COLD JUNCTION COMPENSATION
- 2) TYPE R
- 3) 250°C
- 4) Output ON

Send the following command sequence:

```
r95/K1/LR/O250/S0<CR>
```

r95 = Thermocouple simulation mode activation

K1 = Automatic cold junction compensation (as detailed in the table above)

LR = Type R thermocouple

O250 = 250°C output

S0 = Standby OFF (i.e. output switched ON)

<CR> = Carriage Return (ASCII character 13)

Additional examples:

Type K: Auto CJC: 500°C = r95/K1/LK/O500/S0<CR>

Type K: Auto CJC: 1500°C = r95/K1/LK/O1500/S0<CR>

Type E: Manual CJC (0°C): 400°C = r95/K0/LE/O400/S0<CR>

**Type N: Auto CJC: -100°C = r95/K1/LN/O-100/S0<CR>**

Type K: Manual CJC (24.5°C): 200°C = r95/KT24.5/LK/O200/S0<CR>

If a command includes a value which cannot be set due to, for example, the value being higher than the range maximum, the calibrator will reject the command and stay set as it is (the calibrator will also beep to signify a rejected command)

The calibrator will respond to the commands sent with the response codes as detailed at the beginning of this section. These codes can be used to ensure that hazardous output conditions are clearly indicated to the operator and to maintain control of these outputs. This allows the calibrator to be returned to a safe state once the testing required has been completed (e.g. setting the calibrator back to standby once a test is complete and ensuring this has been successfully achieved and no hazardous outputs remain on the terminals).

This functionality is employed within the ProCal calibration software from Transmille to allow safe operation of the calibrator and to ensure the calibrator is returned to a safe state in between test points and at the completion of a test sequence.

## 8.20 Oscilloscope Calibration Commands (Option)

This function requires the oscilloscope calibration option to be installed in the 3000A Series calibrator - the output via the BNC connector indicated by the green LED.

### 8.20.1 Amplitude

Function	Mode Activation Command	
Amplitude Mode	A1	Amplitude Mode ON
	A0	Amplitude Mode OFF (returns to DCV mode)

Range	Command
5mV/DIV	H1
10mV/DIV	H2
20mV/DIV	H3
50mV/DIV	H4
100mV/DIV	H5
200mV/DIV	H6
500mV/DIV	H7
1V/DIV	H8
2V/DIV	H9
5V/DIV	H10
10V/DIV	H11
20V/DIV	H12
50V/DIV	H13

Amplitude Waveform	
Square Wave	G0
DC	<b>a</b>

The Amplitude function consists of the following commands:

- 1) Amplitude mode activation
- 2) Amplitude range
- 3) Amplitude waveform
- 4) Standby mode command

To enable an amplitude range to be set up, the following command sequence should be used:

<MODE>/<RANGE>/<WAVEFORM>/<STANDBY CONDITION><CR>

For example, to set the following configuration:

- 5) 1V/Division
- 6) Square Wave
- 7) Output ON

Send the following command sequence:

A1/H8/G0/S0<CR>

A1 = Oscilloscope amplitude mode activation

H8 = 1V/Division amplitude range

G0 = Square wave

S0 = Standby OFF (i.e. output switched ON)

<CR> = Carriage Return (ASCII character 13)

Additional examples:

100mV/Division: Square Wave = A1/H5/G0/S0<CR>

10V/Division: DC = A1/H11/G1/S0<CR>

The calibrator will respond to the commands sent with the response codes as detailed at the beginning of this section. These codes can be used to ensure that hazardous output conditions are clearly indicated to the operator and to maintain control of these outputs. This allows the calibrator to be returned to a safe state once the testing required has been completed (e.g. setting the calibrator back to standby once a test is complete and ensuring this has been successfully achieved and no hazardous outputs remain on the terminals).

This functionality is employed within the ProCal calibration software from Transmille to allow safe operation of the calibrator and to ensure the calibrator is returned to a safe state in between test points and at the completion of a test sequence.

## 8.20.2 Timebase

Function	Mode Activation Command
Timebase Mode	R61

Range	Command
5s/DIV	H0
2s/DIV	H1
1s/DIV	H2
500ms/DIV	H3
200ms/DIV	H4
100ms/DIV	H5
50ms/DIV	H6
20ms/DIV	H7
10ms/DIV	H8
5ms/DIV	H9
2ms/DIV	H10
1ms/DIV	H11
500us/DIV	H12
200us/DIV	H13
100us/DIV	H14
50us/DIV	H15
20us/DIV	H16
10us/DIV	H17
5us/DIV	H18
2us/DIV	H19
1us/DIV	H20
500ns/DIV	H21
200ns/DIV	H22
100ns/DIV	H23
50ns/DIV	H24
20ns/DIV	H25

The Timebase function consists of the following commands:

- 1) Timebase mode activation
- 2) Timebase range
- 3) Standby mode command

To enable a timebase range to be set up, the following command sequence should be used:

<MODE>/<RANGE>/<STANDBY CONDITION><CR>

For example, to set the following configuration:

- 4) 1ms/Division
- 5) Output ON

Send the following command sequence:

R61/H11/S0<CR>

R61 = Oscilloscope timebase mode activation

H11 = 1ms/Division timebase range

S0 = Standby OFF (i.e. output switched ON)

<CR> = Carriage Return (ASCII character 13)



Additional examples:

1us/Division = A1/H20/S0<CR>

50ns/Division = A1/H24/S0<CR>

The calibrator will respond to the commands sent with the response codes as detailed at the beginning of this section. These codes can be used to ensure that hazardous output conditions are clearly indicated to the operator and to maintain control of these outputs. This allows the calibrator to be returned to a safe state once the testing required has been completed (e.g. Setting the calibrator back to standby once a test is complete and ensuring this has been successfully achieved and no hazardous outputs remain on the terminals).

This functionality is employed within the ProCal calibration software from Transmille to allow safe operation of the calibrator and to ensure the calibrator is returned to a safe state in between test points and at the completion of a test sequence.

### 8.20.3 Bandwidth (Levelled) Sweep – SCP350/SCP600

Function	Mode Activation Command
BW Sweep Mode	R62

Output	
Set Output	O (not zero)

The bandwidth function consists of the following commands:

- 1) Bandwidth mode activation
- 2) Output value (MHz)
- 3) Standby mode command

To enable a bandwidth to be set up, the following command sequence should be used:

<MODE>/<OUTPUT VALUE>/<STANDBY CONDITION><CR>

For example, to set 400MHz output with the output switched on, the command is:

R62/O400/S0<CR>

R62 = Oscilloscope Bandwidth mode activation

O400 = 400MHZ output

S0 = Standby OFF (i.e. output switched ON)

<CR> = Carriage Return (ASCII character 13)

Additional examples:

50MHz = R62/O50/S0<CR>

600MHz = R62/O600/S0<CR>

If a command includes a value which cannot be set due to, for example, the value being higher than the range maximum, the calibrator will reject the command and stay set as it is (the calibrator will also beep to signify a rejected command)

The calibrator will respond to the commands sent with the response codes as detailed at the beginning of this section. These codes can be used to ensure that hazardous output conditions are clearly indicated to the operator and to maintain control of these outputs. This allows the calibrator to be returned to a safe state once the testing required has been completed (e.g. Setting the calibrator back to standby once a test is complete and ensuring this has been successfully achieved and no hazardous outputs remain on the terminals).

This functionality is employed within the ProCal calibration software from Transmille to allow safe operation of the calibrator and to ensure the calibrator is returned to a safe state in between test points and at the completion of a test sequence.

### 8.20.4 Bandwidth (Levelled) Sweep – SCP6400

Function	Mode Activation Command
BW Sweep Mode	r119

Frequency	
Set Frequency	F<frequency kHz>

Output Power	
Set Power	O<power>

Output	
Set Output	O (not zero)

The bandwidth function consists of the following commands:

- 1) SCP6400 Range Selection
- 2) Output Frequency (kHz)
- 3) Output Power (dBm)
- 4) Standby mode command

To enable a bandwidth to be set up, the following command sequence should be used:

<RANGE>/<OUTPUT FREQUENCY>/<OUTPUT POWER>/<STANDBY MODE>

For example, to set 400MHz output, at 0dBm with the output switched on, the command is:

r119/F400000/O0/S0<CR>

r119 = SCP6400

F400000 = 400MHZ Output (400,000kHz)

O0 = 0dBm output

S0 = Standby OFF (i.e. output switched ON)

<CR> = Carriage Return (ASCII character 13)

Additional examples:

400MHz @ -3 dBm = r119/F400000/O-3/S0<CR>

1.2GHz @ -10 dBm = r119/F1200000/O-10/S0<CR>

If a command includes a value which cannot be set due to, for example, the value being higher than the range maximum, the calibrator will reject the command and stay set as it is (the calibrator will also beep to signify a rejected command)

The calibrator will respond to the commands sent with the response codes as detailed at the beginning of this section. These codes can be used to ensure that hazardous output conditions are clearly indicated to the operator and to maintain control of these outputs. This allows the calibrator to be returned to a safe state once the testing required has been completed (e.g. Setting the calibrator back to standby once a test is complete and ensuring this has been successfully achieved and no hazardous outputs remain on the terminals).

This functionality is employed within the ProCal calibration software from Transmille to allow safe operation of the calibrator and to ensure the calibrator is returned to a safe state in between test points and at the completion of a test sequence.

## 8.20.5 Bandwidth 50kHz Reference

Function	Mode Activation Command
BW Ref (50kHz)	R63

The bandwidth 50 kHz reference function consists of the following commands:

- 5) Bandwidth 50 kHz mode activation
- 6) Standby mode command

To select the 50 kHz reference to be selected, the following command sequence should be used:

<MODE>/<STANDBY CONDITION><CR>

R63/S0<CR>

R63 = Oscilloscope Bandwidth 50 kHz reference mode activation

S0 = Standby OFF (i.e. output switched ON)

<CR> = Carriage Return (ASCII character 13)

The calibrator will respond to the commands sent with the response codes as detailed at the beginning of this section. These codes can be used to ensure that hazardous output conditions are clearly indicated to the operator and to maintain control of these outputs. This allows the calibrator to be returned to a safe state once the testing required has been completed (e.g. setting the calibrator back to standby once a test is complete and ensuring this has been successfully achieved and no hazardous outputs remain on the terminals).

This functionality is employed within the ProCal calibration software from Transmille to allow safe operation of the calibrator and to ensure the calibrator is returned to a safe state in between test points and at the completion of a test sequence.

## 8.21 AC Power Calibration Commands (Option)

This function requires the power calibration option to be installed in the 4000 series calibrator - the output will appear on the voltage terminals and either the low or high current terminals depending on the setting and be indicated by the combined illumination of the voltage and current terminal LEDs.



### UNDERSTANDING POWER

The equations below explain the relationship between Watts, Current, Voltage & Phase Angle.

Active Power:           Watts = Voltage x Current x Cosine  $\theta$

Apparent Power:       VA = Volts x Current

Power Factor:           PF = Active Power / Apparent Power

Phase Angle:            $\theta$  = Angle of AC Current shift from Voltage

Function	Mode Activation Command	
Power Mode	B1	AC Power Mode ON
	B0	Power Mode OFF (returns to DCV mode)

Voltage Setup	
Voltage output (volts)	O (not zero)

Current Setup	
Current output (amps)	C

Phase Setup	
Phase setting (degrees)	M

The power function consists of the following commands:

- 7) Power mode activation
- 8) Voltage output setting
- 9) Current output setting
- 10) Phase relationship in degrees
- 11) Standby mode command

To enable a power output to be set up, the following command sequence should be used:

<MODE>/<VOLTAGE>/<CURRENT>/<PHASE>/<STANDBY CONDITION><CR>

For example, to set the following configuration:

- 12) 200V
- 13) 2A
- 14) 90° Phase
- 15) Output ON

Send the following command sequence:

B1/O200/C2/M90/S0<CR>

- B1 = Power mode activation
- O200 = 200V voltage output
- C2 = 2A current output
- M90 = 90° phase relationship
- S0 = Standby OFF (i.e. output switched ON)
- <CR> = Carriage Return (ASCII character 13)



Additional example:

B1/O500/C10/M180/S0<CR>

B1 = Power mode activation

O500 = 500V voltage output

C10 = 10A current output

M180 = 90° phase relationship

S0 = Standby OFF (i.e. output switched ON)

<CR> = Carriage Return (ASCII character 13)

If a command includes a value which cannot be set due to, for example, the value being higher than the range maximum, the calibrator will reject the command and stay set as it is (the calibrator will also beep to signify a rejected command)

The calibrator will respond to the commands sent with the response codes as detailed at the beginning of this section. These codes can be used to ensure that hazardous output conditions are clearly indicated to the operator and to maintain control of these outputs. This allows the calibrator to be returned to a safe state once the testing required has been completed (e.g. setting the calibrator back to standby once a test is complete and ensuring this has been successfully achieved and no hazardous outputs remain on the terminals).

This functionality is employed within the ProCal calibration software from Transmille to allow safe operation of the calibrator and to ensure the calibrator is returned to a safe state in between test points and at the completion of a test sequence.

Using the optional virtual front panel software from Transmille, additional functionality can be achieved from the power function including energy tests in kWh.

## 8.22 Miscellaneous Commands

### 8.22.1 Earth Relay (Floating or Grounded negative terminals)

Earth Relay	
J0	Earth Relay On
J1	Earth Relay Off

The earth relay command allows the negative terminals to either floating or grounded, depending on the command set. This is also indicated in the display of the calibrator by the -VE symbol (top left).

To set the negative terminals to floating, the command is:

J1<CR>

To set the negative terminals to grounded, the command is:

J0<CR>

<CR> = Carriage Return (ASCII character 13)

### 8.22.2 Reset Calibrator

\*RST<CR> will reset the calibrator to default start up conditions (200mV DC Range, Output Off, Range Hold Off)

### 8.22.3 System ID

\*IDN?<CR> will return a string in the following format:

**<MANUFACTURER>,<MODEL>,<SERIAL NUMBER>,<FIRMWARE VERSION>**

For the 4010, an example response will be:

**TRANSMILLE,4010,12345678,13.0.16**

### 8.22.4 Calibration Mode Enable / Disable

Calibration Mode	
a1	Enable Calibration Mode (Shift Light Illuminates)
a2	Store Calibration (Shift Light turns off), new calibration factors stored
a0	Abort Calibration (Shift Light turns off), any changes to calibration discarded

### 8.22.5 Transmit Displayed Reading

When the 4010 is used with an adapter that provides read back functionality (such as the TPM series of pressure sensors, the EA008 pA/High Resistance measurement adapter etc.) the 4000 series offers the ability to provide measurements in addition to outputs.

To receive the current reading over the interface, the following command should be used:

**READ?**

The calibrator will respond with the current reading, followed by <CR>

# 9 Technical Description

## 9.1 General

The 4000 Series calibrators use the latest in reference, resistor and processor technology designed to minimise cost and size yet maximise performance. The microprocessor controls and monitors all functions of the calibrator. Calibration constants are held in a non-volatile memory allowing the calibration to be performed without removing the covers. There are no internal adjustments required in normal service.



*Warning risk of shock.*

*The line power cord must be disconnected before  
removing the covers of the instrument*

## 9.2 Construction

The calibrator is constructed in a 4U case with fan cooling used for the high voltage and high current amplifiers. The calibrator construction is modular to allow ease of servicing. The rear panel assembly comprises of the mains inlet and transformer, 30 Amp power output amplifier and fan assembly.

The main analogue PCB slides into slots in the case from the rear of the instrument. This plugs into the mother board which is mounted just behind the front panel. The precision reference and D/A converter plugs into the analogue PCB.

The Power supply and switching PCB plugs in to the mother board just above the analogue PCB. The Processor board plugs into this PCB.

## 9.3 Internal Fuses

In normal operation these fuses should never need to be replaced. Only under fault conditions will they require changing.

*Note:*

*To access these fuses it is necessary to dismantle the case, which should only be carried out by a qualified person. See removing top cover.*



*Warning risk of shock.*

*The line power cord must be disconnected before removing the covers of the instrument*

Internal fuses include:
F1: $\pm$ 15V Supply A/S 5Amp 20mm
F2: $\pm$ 15V Supply A/S 5Amp 20mm
F3: $\pm$ 35V Supply A/S 1Amp 20mm
F4: $\pm$ 35V Supply A/S 1Amp 20mm

## 9.4 Opening The Case



*Warning risk of shock.*

*The line power cord must be disconnected before removing the covers of the instrument*

To gain access to the inside of the calibrator, first remove the top cover by removing 6 screws located on the underneath of the calibrator. Carefully draw the rear panel straight back away from the instrument. Note the back panel assembly is heavy with the weight of the mains transformer etc. There are cable assemblies running from the rear panel sub assemble to PCB inside, these cables can be unplugged if required.

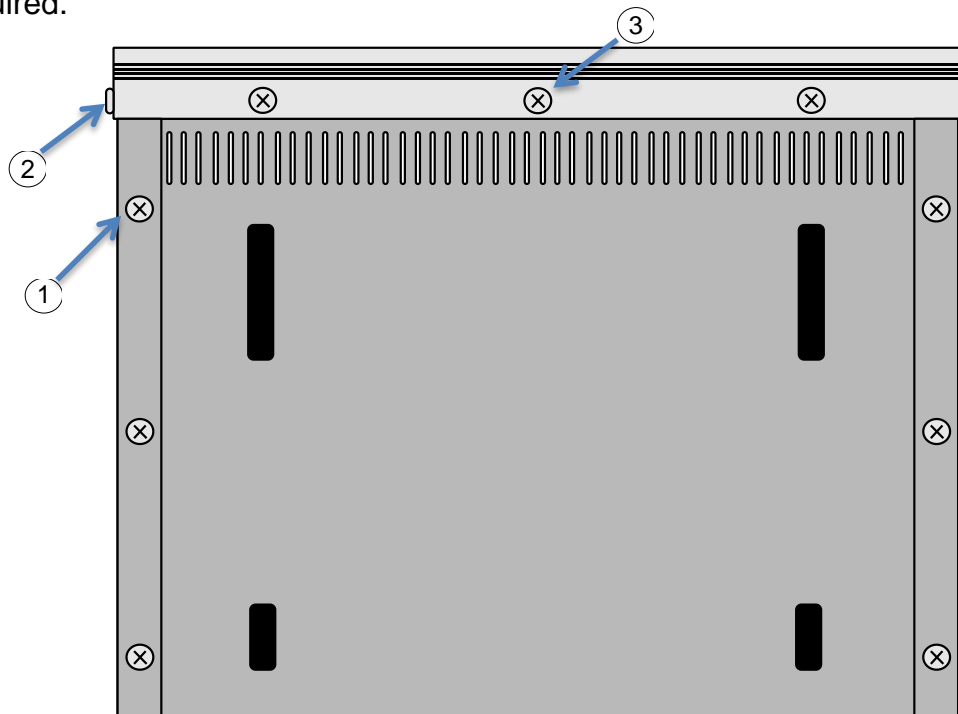

**Figure 87 – Underside of 4000 Series Calibrator**

- ① Remove all six cover fixing screws to enable cover to be removed.
- ② Front Panel side screws require removal to slide cover off enclosure
- ③ Front panel bottom screws only require removal if front panel is to be removed.

*Note:*

*To allow the top cover to be slid back the two side screws must be removed (note the front panel has 3 fixings at the bottom of the panel – these only need to be removed if the front panel needs to be dropped down or removed).*

## 9.5 Access to Internal Fuses – Top Board

After removing the top cover (see above) the metal screening cover of the top PCB must be removed – remove all nylon fixing screws, plus 1 metal screw from far end of PCB cover. The fuses will then be clearly visible (see below):

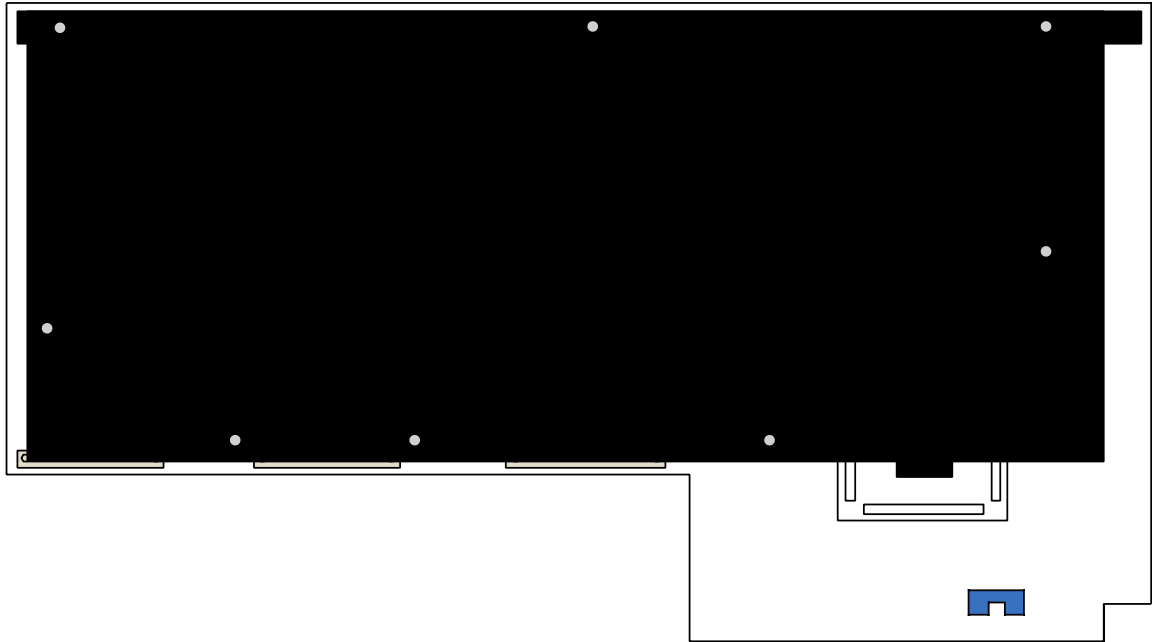

**Figure 88 – Top Board With Cover**

Fuses F1, F2, F3, F4  
located here

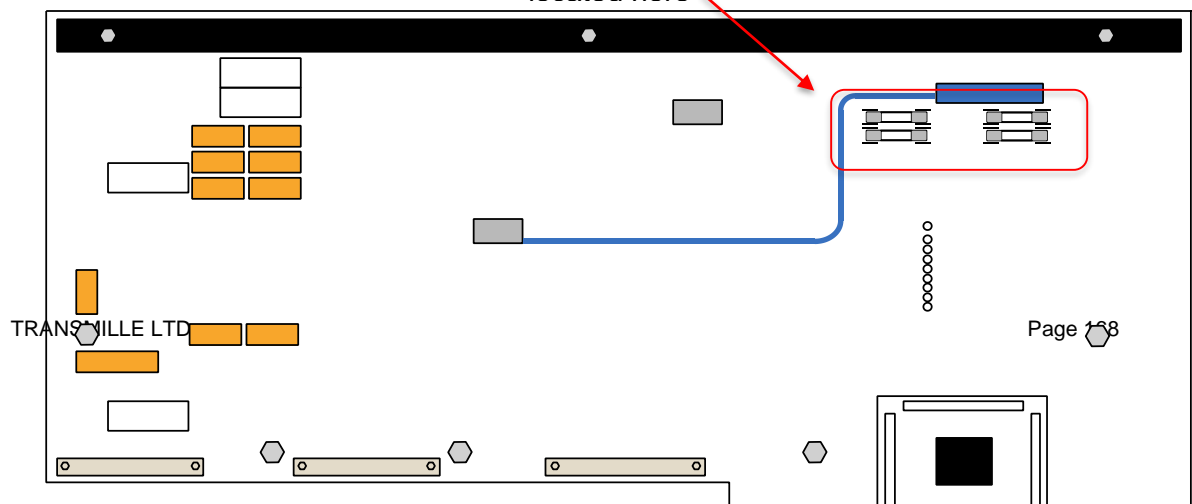
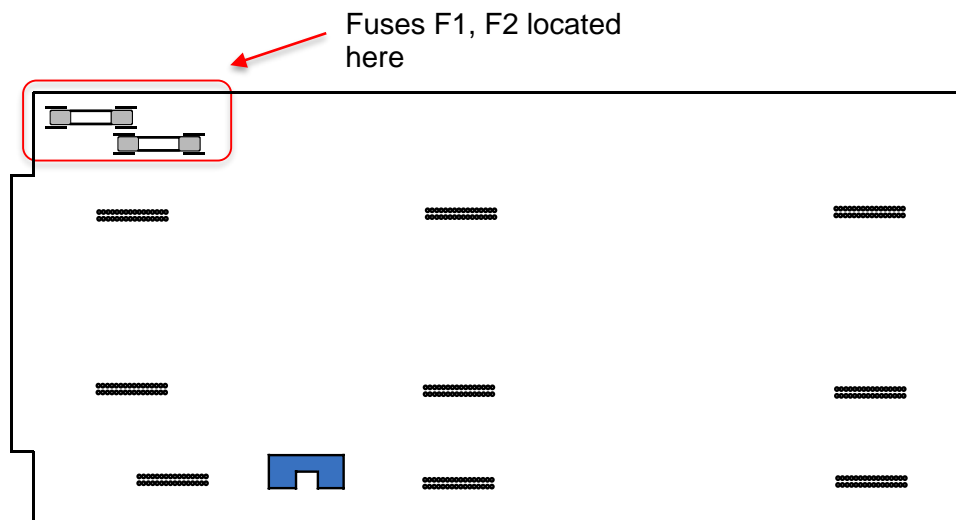



**Figure 89 - Fuse Location on Top Board With Cover Removed**

## 9.6 Access to Internal Fuses – Front Panel PCB

Output protection fuses are located on the front panel PCB. To gain access to these, it is necessary to drop the front panel down – before proceeding, ensure the bottom 3 screws attaching the front panel to the main case are removed (see previous instructions for removing the top cover)



**Figure 90 – Fuse Location on Front Panel PCB**

To allow the front panel to be dropped down for access to the front panel fuses, remove the screws from both sides of the front panel assembly, shown above. The fuses are located in PCB mounted fuse holders as shown above. Replace these fuses with the same type and rating – 2A Ultra Rapid

## 9.7 Power supply and output switching board

On this board is the power supply for the calibrator which is a linear design having the inherent advantage of being low in noise. Supply voltages are  $\pm 5$  Volts,  $\pm 15$  Volts,  $\pm 35$  Volts and unregulated  $\pm 9$  Volts at 30Amps.

The resistance, capacitance and inductance standard also on this PCB which are selected by high performance relays. The resistance outputs can be selected as 4 wire from the program if selected.

## 9.8 Processor Board

Plugs into the Power supply and output switching board and controls all functions within the calibrator with the exception of the high voltage safety cut-out. The processor board is a complete working board containing RAM, PROM, Clock, Cal Ram, I/O and RS232. The processor also applies all calibration factors held in RAM. Cal Factors are stored twice to prevent errors. The processor runs a self-test to detect malfunction and overloads.

## 9.9 Main analogue amplifier and feedback board

This board generates AC and DC voltages and currents which are derived from the D/A boards 0 to 10Volt reference. This reference voltage is compared against the output after it is scaled from either a precision resistive divider of switchable gain for voltage ranges or from a set of precision current shunts for the current ranges. The error signal is amplified to produce the output. To maximise stability there are no adjustment components in the attenuator circuits, all calibration uses correction calibration factors stored in the non-volatile memory of the processor.

AC outputs are produced using digital signal processing to produce an accurate stable low distortion sine wave. The amplitude of this waveform is controlled by the

difference signal from the DC Reference from the D/A and the DC output from a high performance true RMS converter.

## 9.10 High Voltage Amplifier and Output

All outputs above 20 volts use this amplifier. A high power 150W IC amplifier running from 25 volt supplies with thermal and output overload protection output is switched into either a high frequency ferrite transformers or a LF iron laminate transformer depending on the frequency to produce all high voltage outputs. For DC outputs the signal is first chopped to provide an AC square wave at approx. 10 kHz before being fed to the Power amp. The output from these transformers is rectified to produce a DC output or used directly for AC. A safety cut out circuit in the secondary windings of the transformers will disconnect the input to the amplifier in the event of excessive output current. This cut out is independent of processor control and once tripped will remain in an off state until reset by the processor. All high voltage switching is performed by relays. To maximise contact life relays are only operated when the amplifier is in standby.

## 9.11 Current Trans conductance Amplifier

A low voltage high current amplifier is used for current outputs powered from the unregulated 9 volt 30 amp supply. A pair of high power transistors on the heat sink before the fan are the final output stage of this amplifier. The output from this stage is switched to either the low current output terminals or the 30 amp output terminals.

## 9.12 Output Currents Sensing & Shunts

Six high stability current shunts with low temperature coefficients from 4kOhms to 0.01ohm provide feedback for the current ranges. The lower values are switched using a four wire method for optimum accuracy, there is no provision for the adjustment of the value of the shunts and calibration is performed by the calibration factors. The 30Amp range shunt is mounted on the heat sink assembly on the rear panel.

Output from the shunts is fed to a low drift differential amplifier which is used to reference the current shunts output to system ground. Analogue switches set the trans conductance amplifier to standby when range changing and when on voltage ranges. This prevents high current spikes being produced during range changing.

# 10 Calibration Tutorial

## 10.1 Getting the best out of the calibrator.

The 4000 Series are very accurate calibrators producing a very wide range of output signals. To make the best possible use of the range of outputs and to eliminate errors this section details some common sources of errors and offers some techniques to reduce them.

## 10.2 Making Good Measurements

Transmille provide free of charge online training via our website ([www.transmille.com](http://www.transmille.com)) as well as our YouTube channel ([www.youtube.com/Transmille](http://www.youtube.com/Transmille)).

In these videos we demonstrate common errors in measurement technique in a visual format showing both the effects, as well as how to best mitigate these effects.

## 10.3 Thermally generated EMF voltage errors.

At every connection in a measuring system different metals come into contact with each other, each junction forms a thermocouple. The voltages generated at these junctions are called thermoelectric voltages and are dependent on the type of metals in contact and the difference in temperature.

This effect, of course, is used to measure temperature with thermocouples, however this effect will cause large errors in low voltage measurements, as thermocouple voltages for some metals can be in the millivolt region. Copper is best but many standard test plugs are made from nickel plated brass and should not be used.

Gold plated copper plugs are available for low level work. If the test lead has been in use on a high current range this will have made the plug warm, which will also increase the error.

## 10.4 Lead/Connection Resistance

When measuring resistance, it is important to ensure that the correct lead type and connections are used, as there are noticeable effects at both low and high values of resistance.

At low values of resistance, 4 wire connections should be used where possible, as well as ensuring that all connections are clean and free of contaminants. Leads and their connections can have up to 100mOhms of resistance, which can cause large errors in relation to the specification of both the calibrator as well as the UUT.

Leads should be nulled out by the user to ensure that the resistance of the leads used are not added to the indicated measurement by the UUT.

For high value resistance measurement, it is important to ensure that the insulation resistance of the leads used (the resistance between the conductor and the insulator) is suitably high. If the insulation resistance is not suitable high, the effect is equivalent to placing a resistor in parallel with the sourced resistor, reducing the resistance seen by the UUT.

An example of this is a set of leads with an insulation resistance of 10GOhm. The calibrator is used to source an output of 1GOhm. An error of 10% will be seen by the UUT, this is due to the resistance of the leads.

When High Resistance is being sourced low cost 'ultra flex' leads should not be used, although these leads are very resilient to wear and tear in daily use, these leads are not suitable for precision measurements of high value resistance. Coaxial

leads with high insulation resistance should be used, with insulation such as PTFE, and with screening to prevent power line and noise pickup.

## 10.5 Power line and low frequency Pick up and noise

These effects are most noticeable when using high resistance (100kohms and above) and low current. All constant current sources have a very high output impedance which will pick up noise just like the high value resistance. To reduce pickup, use screened leads and try earthing the low side of the calibrator output.

For high value resistance it is essential that the cables insulation resistance will not affect the accuracy. Most PVC cables will only have insulation resistance of around  $10G\Omega$ ; this will give an error of 1% on the 100mohm output.

Low AC Current is particularly difficult as the capacitance of screened leads will shunt some of the current away.

# 11 Calibration and Maintenance



## WARNING

*The information in this section is intended only for qualified personnel.  
The user must at all times be adequately protected from electric shock.*

## 11.1 General

The 4000 Series calibrators maintenance requirements are listed below. Please note that the calibrator does not require any regular internal servicing or adjustment.

- Electrical Safety Checks on Line power lead and case
- Cleaning of the Fan
- Cleaning the external case
- Calibration and operation verifications

## 11.2 Electrical Safety Tests

These can be carried out as frequently as required. Earth bond and insulation can be tested as a class 1 standard. Flash testing is not recommended due to the possibility of damage to internal components.



## 11.3 Cleaning of the Fan Duct



*WARNING : Risk of Shock*

*Ensure calibrator is disconnected from line power  
before proceeding.*

Fan ducts may be cleaned with brush and vacuum cleaner

## 11.4 Cleaning the external case

Use a damp cloth with a mild water based cleaner for the outside case and front panel. Do not use alcohol based cleaners or solvents and do not spill or allow liquid to enter the case.

## 11.5 Calibration

To adjust the 4000 Series calibrator, the calibrator can either be connected to a computer via the USB interface. Calibration constants stored within the calibrator can then be adjusted using the Virtual Front Panel software. To prevent unauthorised use of this software, a password is required before access is granted. Adjustment can be completed without disassembly of the calibrator.

The 4000 Series calibrator also includes the facility to adjust outputs using the front panel controls. Calibration constants stored within the calibrator can then be adjusted.



*REFER TO THE CALIBRATION MANUAL FOR CALIBRATION  
PROCEDURE.*

*THE CALIBRATION OF THE INSTRUMENT SHOULD ONLY BE  
CARRIED OUT  
BY QUALIFIED PERSONNAL*

## 12 Guarantee and service

Transmille Ltd. guarantees this instrument to be free from defects under normal use and service for a period of 3 years from purchase. This guarantee applies only to the original purchaser and does not cover fuses, or any instrument which, in Transmille' s opinion, has been modified, misused or subjected to abnormal handling or operating conditions.

Transmille' s obligation under this guarantee is limited to replacement or repair of an instrument which is returned to Transmille within the warranty period. If Transmille determines that the fault has been caused by the purchaser, Transmille will contact the purchaser before proceeding with any repair.

To obtain repair under this guarantee the purchaser must return the instrument in its original packaging (carriage prepaid) and a description of the fault to Transmille at the address shown below. The instrument will be repaired at the factory and returned to the purchaser, carriage prepaid.

**Note:**

**TRANSMILLE ASSUMES NO RESPONSIBILITY FOR DAMAGE IN TRANSIT**

**THIS GUARANTEE IS THE PURCHASER'S SOLE AND EXCLUSIVE GUARANTEE AND IS IN LEIU OF ANY OTHER GUARANTEE, EXPRESSED OR IMPLIED. TRANSMILLE SHALL NOT BE LIABLE FOR ANY INCIDENTAL, INDIRECT, SPECIAL OR CONSEQUENTIAL DAMAGES OR LOSS.**



**Transmille Ltd.  
Unit 4, Select Business Centre  
Lodge Road  
Staplehurst  
Kent  
TN12 0QW  
United Kingdom**

**Tel: +44 0 1580 890700  
Fax: +44 0 1580 890711**

**Email: [sales@transmille.com](mailto:sales@transmille.com)  
Web: [www.transmille.com](http://www.transmille.com)**

# 4000 Series Fax Back Form



Transmille Ltd.  
Unit 4, Select Business Centre  
Lodge Road  
Staplehurst  
Kent.  
TN12 0QW  
United Kingdom.

Your 4000 Series Multi-Product Calibrator is fitted with a *security system* which requires a *security code* to be entered to allow continued operation of the unit beyond the 65 Day evaluation period.

Please complete the following details:

Company Name: \_\_\_\_\_

Contact Name: \_\_\_\_\_

Address: \_\_\_\_\_

\_\_\_\_\_

\_\_\_\_\_

\_\_\_\_\_

Country: \_\_\_\_\_

Tel: \_\_\_\_\_

Fax: \_\_\_\_\_

Instrument Model: **4000 Series Multi-Product Calibrator**

Serial Number: \_\_\_\_\_

Please Fax This Form To : +44 (0) 1580 890711

On receipt of this fax Transmille will, on receipt of payment for the calibrator, send details of the security code with details on how to enter this code.

# Appendix A

## Installing the USB Interface Driver (Windows XP)

Insert the supplied USB lead driver CD into the computer CD drive

Click on menu to install driver –  
follow on screen prompts.



Connect the USB lead to the INSTRUMENT and connect to the computer

Windows will detect a new device is connected - Select **No, not this time** when asked if a Windows update search should be run

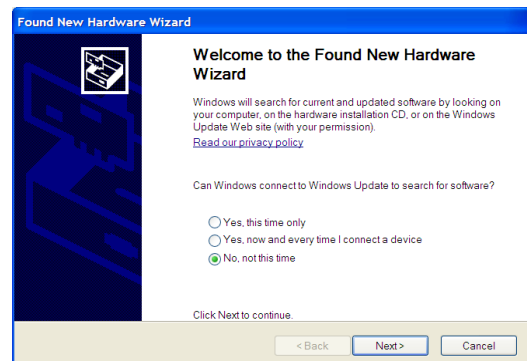

Select **Install the software automatically** to begin driver installation

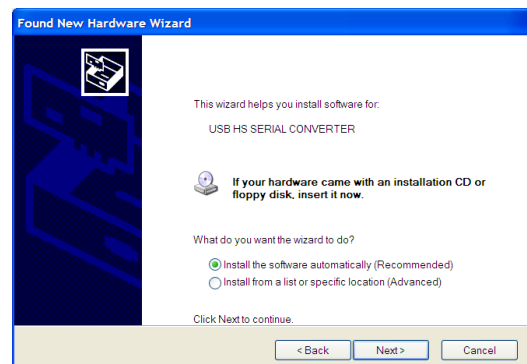

Once located Windows will install the driver and complete the installation.

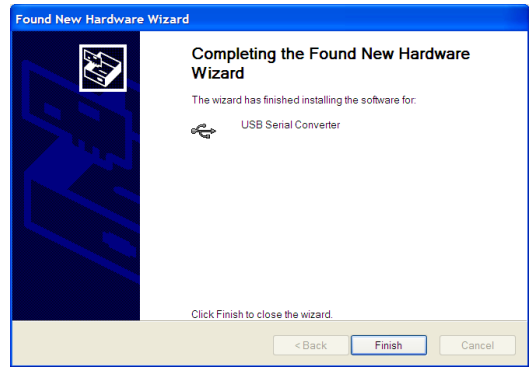

## Installing the USB Interface Driver (Windows Vista / 7)

Insert the supplied USB lead driver CD into the computer CD drive

Click on menu to install driver –  
follow on screen prompts.



Connect the USB lead to the INSTRUMENT and connect to the computer

Click Locate and Install driver software



Windows will begin installation



Windows will install device driver

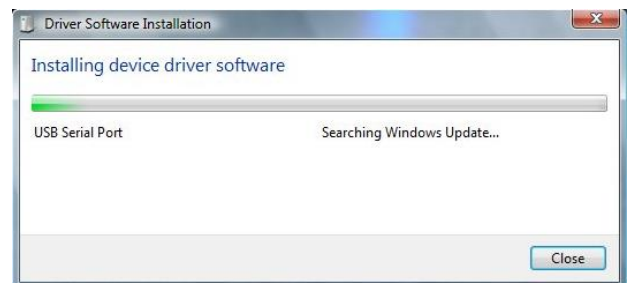

Once installed, Windows will display the allocated COM Port in brackets as shown:

Note : The COM port number can be checked at any time by using Windows Control Panel.  
[see instructions on next page].

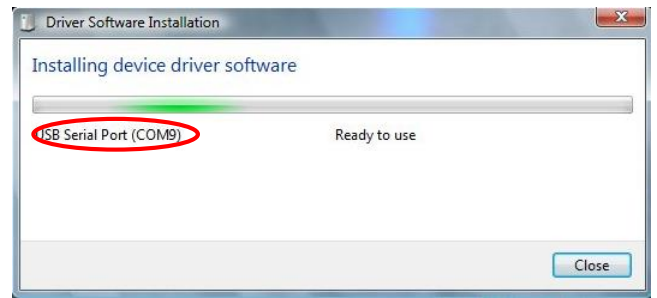



## Checking the COM Port setting for the USB Interface

Once the USB interface driver is installed, it will have assigned a 'virtual' COM port number which is needed for setting up the instrument for computer control (via optional ProCal Calibration software). To determine the COM port number, follow the steps below:

Open Windows Control Panel

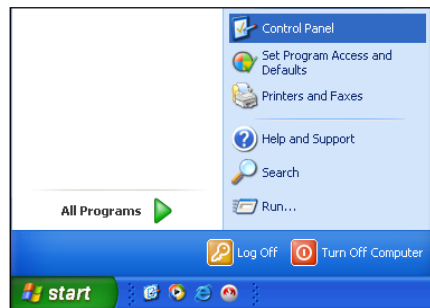

Select the **SYSTEM** icon

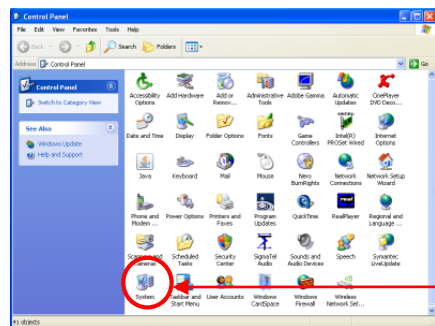

Select the **Hardware** tab, then click the **Device Manager** button

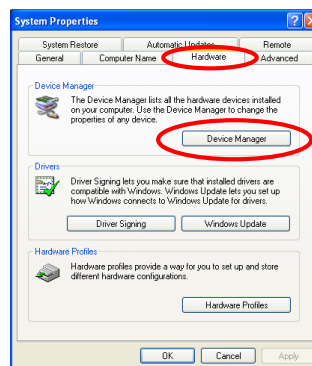

Select **Ports (COM & LPT)** - the virtual COM Port number assigned is shown in brackets

